

PROFESSIONAL

Model PMD660 User Guide

Portable Solid State Recorder

marantz®

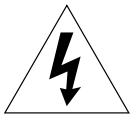

CAUTION
RISK OF ELECTRIC SHOCK
DO NOT OPEN



**CAUTION: TO REDUCE THE RISK OF ELECTRIC SHOCK,
DO NOT REMOVE COVER (OR BACK).
NO USER-SERVICEABLE PARTS INSIDE.
REFER SERVICING TO QUALIFIED SERVICE PERSONNEL.**



The lightning flash with arrowhead symbol within an equilateral triangle is intended to alert the user to the presence of uninsulated "dangerous voltage" within the product's enclosure. It may be of sufficient magnitude to constitute a risk of electric shock to persons.



The exclamation point within an equilateral triangle is intended to alert the user to the presence of important operating and maintenance (servicing) instructions in the literature accompanying the product.

WARNING

**TO REDUCE THE RISK OF FIRE OR ELECTRIC SHOCK,
DO NOT EXPOSE THIS PRODUCT TO RAIN OR MOISTURE.**

CAUTION:

**USE OF CONTROLS OR ADJUSTMENTS OR PERFORMANCE
OF PROCEDURES OTHER THAN THOSE SPECIFIED HEREIN
MAY RESULT IN HAZARDOUS RADIATION EXPOSURE.**

WARNINGS

Do not expose the equipment to rain or moisture.

Do not remove the cover from the equipment.

Do not insert anything into the equipment through the ventilation holes.

Do not cover the ventilation with any items such as tablecloths, newspapers, curtains, etc.

No naked flame sources, such as lighted candles, should be placed on the equipment.

When disposing of used batteries, please comply with governmental regulations or environmental public instruction's rules that apply in your country or area.

When setting up the recorder ensure that:

- it will not be exposed to interference from external equipment.
- it will not be exposed to electrostatic discharges.
- it will not be exposed to direct sunlight.
- heavy objects are not placed on the recorder.

Copyright

Recording and playback of any material may require consent. For further information refer to the following US ordinances:

- Copyright act of 1956
- Dramatic and Musical Performance Act 1958
- Performers Protection Acts 1963 and 1972
- any subsequent statutory enactments and orders

IMPORTANT SAFETY INSTRUCTIONS

READ BEFORE OPERATING EQUIPMENT

This product was designed and manufactured to meet strict quality and safety standards. There are, however, some installation and operation precautions which you should be particularly aware of.

1. Read Instructions – All the safety and operating instructions should be read before the product is operated.
2. Retain Instructions – The safety and operating instructions should be retained for future reference.
3. Heed Warnings – All warnings on the product and in the operating instructions should be adhered to.
4. Follow Instructions – All operating and use instructions should be followed.
5. Cleaning – Unplug this product from the wall outlet before cleaning. Do not use liquid cleaners or aerosol cleaners. Use a damp cloth for cleaning.
6. Attachments – Do not use attachments not recommended by the product manufacturer as they may cause hazards.
7. Water and Moisture – Do not use this product near water-for example, near a bath tub, wash bowl, kitchen sink, laundry tub, swimming pool, or in a wet basement.
8. Accessories – Do not place this product on an unstable cart, stand, tripod, bracket, or table. The product may fall, causing serious injury to a person and damage to the product. Use only with a cart, stand, tripod, bracket or table recommended by the manufacturer, or sold with the product. Any mounting of the product should follow the manufacturer's instructions, and should use a mounting accessory recommended by the manufacturer.
9. A product and cart combination should be moved with care. Quick stops, excessive force, and uneven surfaces may cause the product and cart combination to overturn.



10. Ventilation – Slots and openings in the cabinet are provided for ventilation, to ensure reliable operation of the product, and to protect it from overheating. These openings must not be blocked or covered. They should never be blocked by placing the product on a bed, sofa, rug, or other similar surface. This product should not be placed in a built-in installation such as a bookcase or rack unless proper ventilation is provided, or the manufacturer's instructions have been adhered to.
11. Power Sources – This product should be operated only from the type of power source indicated on the marking label. If you are not sure of the type of power supply to your home, consult your product dealer or local power company. For products intended to operate from battery power or other sources, refer to the operating instructions.
12. Power-Cord Protection – Power-supply cords should be routed so that they are not likely to be walked on or pinched by items placed upon or against them. Pay particular attention to cords at plugs, convenience receptacles, and the point where they exit from the product.
13. Protective Attachment Plug – The product is equipped with an attachment plug having overload protection. This is a safety feature. See Instruction Manual for replacement or resetting of protective device. If replacement of the plug is required, be sure the service technician has used a replacement plug specified by the manufacturer that has the same overload protection as the original plug.
14. Lightning – For added protection for this product during a lightning storm, or when it is left unattended and unused for long periods of time, unplug it from the wall outlet and disconnect the antenna or cable system. This will prevent damage to the product due to lightning and power-line surges.
15. Overloading – Do not overload wall outlets, extension cords, or integral convenience receptacles as this can result in a risk of fire or electric shock.
16. Object and Liquid Entry – Never push objects of any kind into this product through openings. They may touch dangerous voltage points or short-out parts that could result in a fire or electric shock. Never spill liquid of any kind on the product.

17. Servicing – Do not attempt to service this product yourself as opening or removing covers may expose you to dangerous voltage or other hazards. Refer all servicing to qualified service personnel.
18. Damage Requiring Service – Unplug this product from the wall outlet and refer servicing to qualified service personnel under the following conditions:
 - a. When the power-supply cord or plug is damaged.
 - b. If liquid has been spilled, or objects have fallen into the product.
 - c. If the product has been exposed to rain or water.
 - d. If the product does not operate normally by following the operating instructions. Adjust only those controls that are covered by the operating instructions. Improper adjustment of other controls may result in damage and often requires extensive work by a qualified technician to restore the product to its normal operation.
 - e. If the product has been dropped or damaged in any way.
 - f. When the product exhibits a distinct change in performance.
19. Replacement Parts – When replacement parts are required, be sure the service technician uses replacement parts specified by the manufacturer or that have the same characteristics as the original part. Unauthorized substitutions may result in fire, electric shock, or other hazards.
20. Safety Check – Upon completion of any service or repairs to this product, ask the service technician to perform safety checks to determine that the product is in proper operating condition.
21. Wall or Ceiling Mounting – The product should be mounted to a wall or ceiling only as recommended by the manufacturer.
22. Heat – The product should be situated away from heat sources such as radiators, heat registers, stoves, or other products (including amplifiers) that produce heat.

NOTE TO CATV SYSTEM INSTALLER:

This reminder is provided to call the CATV (Cable-TV) system installer's attention to Section 820-40 of the NEC which provides guidelines for proper grounding. In particular, it specifies that the cable ground shall be connected to the grounding system of the building, as close to the point of cable entry as practical.

NOTE:

This equipment has been tested and found to comply with the limits for a Class A digital device, pursuant to Part 15 of the FCC Rules.

These limits are designed to provide reasonable protection against harmful interference when the equipment is operated in a commercial environment.

This equipment generates, uses, and can radiate radio frequency energy and, if not installed and used in accordance with the instruction manual, may cause harmful interference to radio communications.

Operation of this equipment in a residential area is likely to cause harmful interference in which case the user will be required to correct the interference at this own expense.

NOTE:

Changes or modifications may cause this unit to fail to comply with Part 15 of the FCC Rules and may void the user's authority to operate the equipment.

CE marking (only EU version)

- Ⓒ **English**
This product is in conformity with the EMC directive and low-voltage directive.
- Ⓒ **Français**
Cet appareil est conforme à la directive EMC et à la de directive sur les basses tensions.
- Ⓒ **Deutsch**
Dieses Gerät entspricht den EMC-Richtlinien und den Richtlinien für Niederspannungsgeräte.
- Ⓒ **Nederlands**
Dit apparaat voldoet aan de EMC-richtlijnene en de richtlijnen voor apparatuur met laag voltage.
- Ⓒ **Italiano**
Quest' unità è conforme alle direttive EMC ed alla direttiva sulle basse tensioni.
- Ⓒ **Português**
Esta unidade está em conformidade com as directivas EMC e as directivas de baixa voltagem.
- Ⓒ **Español**
Esta unidad estáde acuerdo con las normas EMC y las relacionadas con baja tensión.

Equipment mains working system

This product complies with household power and safety requirements in your area.

This Class A digital apparatus complies with Canadian ICES-003.

Cet appareil numérique de la Classe A est conforme á la norme NMB-003 du Canada.

SI DICHIARA CHE L'APPARECCHIO SINTO-AMPLIFICATORE SR-39
RISPONDE ALLE PRESCRIZIONI DELL'ART. 2 COMMA 1 DEL D.M. 28
AGOSTO 1995 N° 548.

FATTO A EINDHOVEN, IL 1/1/1997.

MARANTZ EUROPE B.V.
5600 EINDHOVEN
THE NETHERLANDS

"Este aparato lleva elementos antiparasitarios necesarios para cumplir con los límites que se establecen en el Anexo V del Reglamento sobre Perturbaciones Radioeléctricas e Interferencias aprobado en el Real Decreto 138/1989. (B.O.E. de 9 Febrero 1989)."

Table of Contents

Package contents	3	Recording Format parameters	21
Introduction	4	Recording time chart	21
Features	4	Recording Level Control	22
Preparation	6	Microphone Attenuator	22
Installing the carry strap	6	Pre Record	22
Installing batteries	6	Silent Skip (Automatic Pause Recording)	22
Controls and Connections	7	Add a Track manually	22
Top side	7	Add a Track automatically	23
Front side	12	Playback	23
Left / Right side	13	Connection Diagram	23
Rear side	14	Playback Procedure	24
Display	15	Track Access	24
Basic operation	16	Search	24
CF cards	17	Audible Search	25
To insert a CF card	17	Audio output for playback	25
To eject a CF card	17	EDL Mark	25
CF card security	18	Add an EDL mark manually	25
CF card Format	18	Search the EDL mark	25
Recording	19	Add an EDL mark automatically	26
Connection Diagram	19	Edit	26
Recording Procedure	19	1. Trk Erase (How to erase tracks)	27
Audio input for recording	20	2. TrkMkErase (How to erase all EDL marks within one track)	27
		3. AllMkErase (How to erase all EDL marks)	28
		4. Format (How to format a CF card)	28

Virtual Track and Copy Segment	29	Additional Functions	38
Virtual Track	29	Battery	38
Copy Segment	29	Auto power off	38
Virtual Track Edit Mode	29	Beep Alarm	38
Creating a Virtual Track	30	Key lock	39
Using Copy Segment to		Set Date and Time	39
create a new file	31	LED level meter	39
Entering Virtual Playback mode	32	Phantom Power	39
Virtual Track EDIT mode	33	Display	40
Copy SEG?		Preset Setup	41
[How to convert a Virtual Track to a new file]	33	Table of Preset defaults (USA)	42
Copy SEG A?		Table of Preset defaults (Europe)	43
[How to convert all Virtual Tracks to new files]	34	Troubleshooting	55
VT Erase?		Error Message	57
[How to erase a Virtual Track]	34	Specifications	58
AVT Erase?		LIMITED WARRANTY - USA	59
[How to erase all Virtual Tracks]	35		
USB mode	36		
Computer compatible	36		
How to connect via the USB port	36		
Diagram of file structure	37		
Machine ID	37		

Package contents

- PMD660

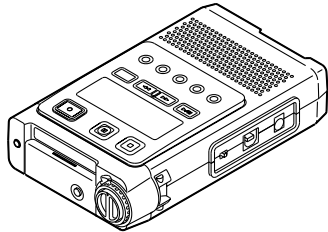

- 64MB CF card (US only)
(shipped formatted and installed)



- AC adapter



- USB cable

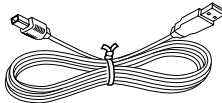

- Audio cable

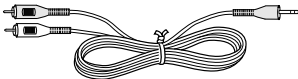

- Carry strap

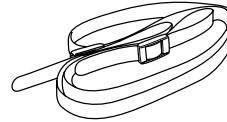

- Security screws (2)
ISO 3x10 (3mm x 10mm long) For CF card door.

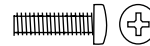

- Plastic pin and retainer
(spare - for Memory compartment door)



- CD-ROM
Contents of the CD may vary.
Contents usually include:

- PDF format manual(s)
Several languages may be included.
- Demonstration copy of PMDEdit software
- Instructions for obtaining full copy of PMDEdit

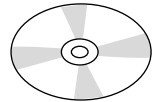

- This User Guide
- Customer Registration Document

Introduction

Thank you for selecting the Marantz Professional PMD660 Portable Solid State Recorder.

The PMD660 is an audio recorder that records in digital audio formats onto a Compact Flash™ memory card (CF card) or Microdrive™.

CF cards, also used in digital cameras, are widely available at consumer electronics retailers and computer resellers.

Features

- Stereo (2 channels) and mono (1 channel) audio recording and playback.
- Audio inputs may be from :
 - the built-in microphone(s),
 - condenser or dynamic microphone(s) connected to the MIC IN jacks, or
 - line level audio sources connected to the LINE IN jack.
- Audio outputs may be from :
 - the built-in speaker,
 - headphones connected to the PHONES jack, or
 - analog audio devices such as an amplifier or other devices connected to the LINE OUT jack.
- Records onto various types of CF cards. (Please refer to the Marantz Professional web site www.d-mpro.com for what kind of media are recommended.)
- Computer compatible
The PMD660 records directly onto CF cards. Recordings can be transferred to your desktop or laptop computer by removing the CF card from the PMD660 or by connecting the PMD660 to your computer via the USB port. Audio recorded in the popular MP3 compression format is directly available for intranet or internet file sharing.
 - An editing program (Marantz Professional's PMDEdit application software, available from Marantz Professional for PC users) lets you convert and edit audio files that were recorded on the PMD660.
 - MS-DOS™ and Windows compatible file system.
- Easy one control recording
Simply push the REC button.
- Automatic recording
The PMD660 can be set to stop recording when there is silence (Silent Skip) and automatically start when sound resumes. The PMD660 can be set to automatically add an EDL mark to the track at each such starting point.
- Manual and automatic record level control (ALC).
- Two different recording formats :
 - Compressed recording using MPEG1 Layer III (MP3) mono and stereo.
 - MP3 compressed at 128kbps (stereo) or 64kbps (mono).
 - Uncompressed recording using 16-bit linear Pulse Code Modulation (PCM).

- **Security – CF cards**
For security, the CF card compartment door can be secured with a screw. Requiring a tool to open the CF card compartment reduces casual removal of the CF card.
- **Pre-Recording memory buffer records 2 seconds of audio before recording is started.**
- **Playback aids**
A common problem with lengthy voice or other recordings is difficulty in locating one or more specific passages for playback. The PMD660 has several ways to mark specific record starting points.
- **Tracks**
 - A new track (file) is automatically started each time you begin a recording.
 - It is not possible to record over a previously recorded track unless it is first erased.
 - An Auto Track feature can add tracks every minute or other selected recording intervals. (Minute track: Setting the interval to one minute provides a new track every minute of a recording. This permits navigation of a large audio recording by time.)
 - A new track can be started during recording by pressing the REC button (if the "Manual Trk" preset is turned On).
- **EDL marks***
EDL (Edit Decision List) marks can be created during recording manually or automatically. EDL marks help you find specific points in the recording.
 - During playback, you can instantly locate EDL marks.
 - Up to 255 EDL marks can be added to a CF card. EDL marks are numbered consecutively starting at one. During recording, you can manually add an EDL mark by pushing the MARK button. EDL marks can also be added automatically.

* The EDL marking system is proprietary to Marantz Professional solid state recorders.
- **Virtual Track**
Virtual Track allows you to set an in point and an out point within a file for later immediate playback access.
- **Copy Segment**
Copy Segment works just like the copy and paste function of your standard word processing program. It allows you to "highlight" a section of a track(file) by setting an in point and an out point, and then paste that section into a new track(file) without destroying the original track(file).
- **Setup**
Three menu selectable Presets make it easy to switch between your commonly used input, recording format and other menu selections.
- **Time / Date stamp**
A built-in date and time generator marks (stamps) the beginning of each track.
- There are three ways to power the PMD660 ;
 - Included AC adapter.
 - AA Alkaline batteries (~ 4 hours).
 - Rechargeable Ni-MH batteries.
- **REMOTE jack for optional Marantz Model RC600PMD permits a wired remote for controlling the recording process.**

Preparation

Installing the carry strap

1. Put the carry strap through the shaft of PMD660.

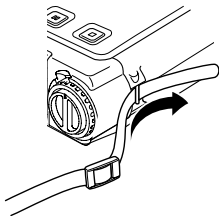

2. Put the carry strap through the stopper of PMD660.

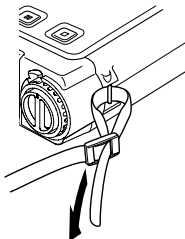

3. Secure the carry strap by putting it through the second stopper.

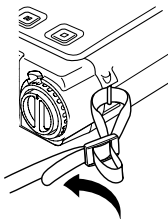

Installing batteries

1. Remove the battery compartment.

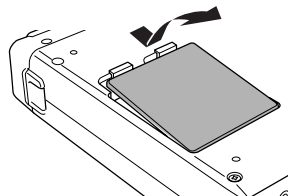

2. Insert the new batteries (AA type) with correct +/- polarity.

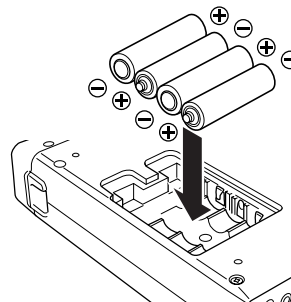

3. Close the battery compartment.

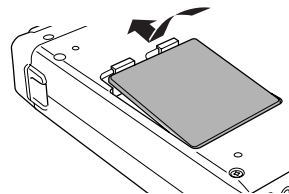

Controls and Connections

Top side

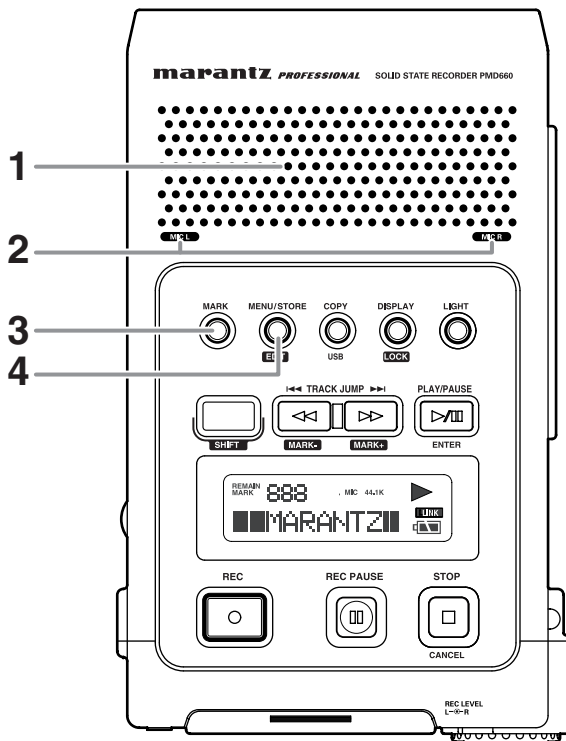

1. Speaker

When "Output" in the preset menu is set to SP/HP, the played back audio signal is output the internal speaker. Headphones plugged into the PHONES jack mute the internal speaker. HP/SPK VOL controls the built-in Speaker and Headphone volume.

See Page 44, How to select an output for playback.

2. MIC (internal microphones)

3. MARK button

Push the MARK button to add an EDL Mark manually during pause, recording, or playback.

Adding an EDL Mark during recording introduces an audible click in the recording when using the internal microphone.

4. MENU / STORE / EDIT button

• MENU

Menu, accessed from stop by pushing the MENU button, lets you set or change recording and playback parameters, such as changing inputs and setting the Date and Time.

• STORE

Push the STORE button while in the preset menu to write menu changes and return to stop mode. See page 41, How to set or change the preset parameters.

• EDIT

Edit menu, accessed from stop by pushing and holding the SHIFT button then pushing the EDIT button, lets you erase tracks, erase EDL marks and format the CF card.

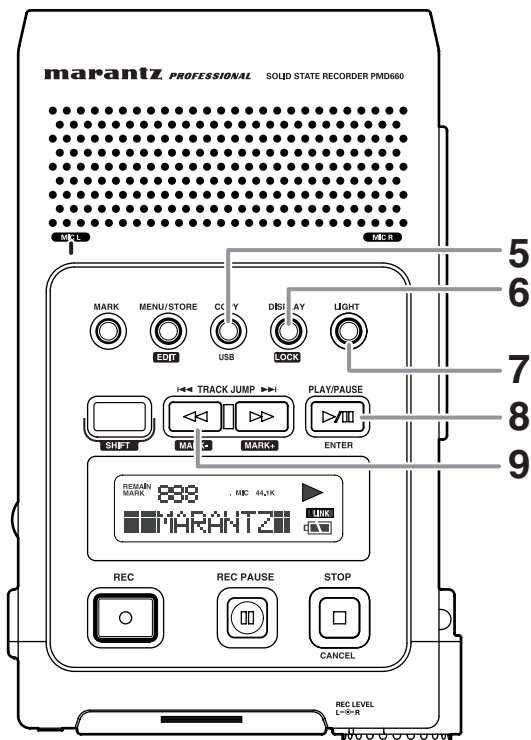

5. COPY / USB button

- **Copy (Copy segment)**

During playback, push the COPY button to copy mode and setup the start point and end point.

See page 29, How to Virtual Track and Copy Segment.

- **USB**

Push and hold the USB button while you turn on the PMD660's POWER switch.

The CF card in the PMD660 appears as an external drive on a connected computer. It may also be removed for data transfer.

See page 36, How to connect via the USB port.

6. DISPLAY / LOCK button

- **DISPLAY**

Push to tab through alternate information displays.

Displays are slightly different in Stop, Record and Play. See Page 40, Display, for more information.

- **LOCK**

Secures the PMD660 in its present state during Record, Playback or Stop.

Push and hold the SHIFT button while pushing the DISPLAY/LOCK button to lock all functions except the LIGHT button.

7. LIGHT button

Push the LIGHT button to momentarily turn the Display light on.
Push and hold for one second to switch the Display light on. Push to switch the Display light off.

8. PLAY/PAUSE / ENTER button

• PLAY/PAUSE (playback)

From stop, push to begin playback.
During playback, push to pause playback.
During play - pause, push to resume playback.

• ENTER (menu)

During menu functions, push to accept the current setting and switch to the next menu item to be set.

9. TRACK JUMP ◀◀ / ◀◀ / MARK- button

• TRACK JUMP ◀◀

During playback, push to jump to the previous track.
If pushed while playing, the first track jumps to the last track on the CF card.

• ◀◀

- During playback, push and hold the ◀◀ button to "rewind" and do a 2X speed audible search in the reverse direction. Release to return to normal forward playback.
- During play - pause, push and hold the ◀◀ button to rewind quickly. The rewind is at 10X speed for three seconds, then it automatically speeds up to 140x speed.

Notes:

If the ◀◀ button is held past the beginning of a track, the rewind will continue into the previous track.
During Edit menu and Menu functions, push the ◀◀ button to increment a parameter in the - direction.

• MARK-

From Stop push and hold the SHIFT button while pushing the Mark- button to tab through the EDL marks on the CF card.
To start playback from the displayed EDL Mark, push the PLAY/PAUSE button.

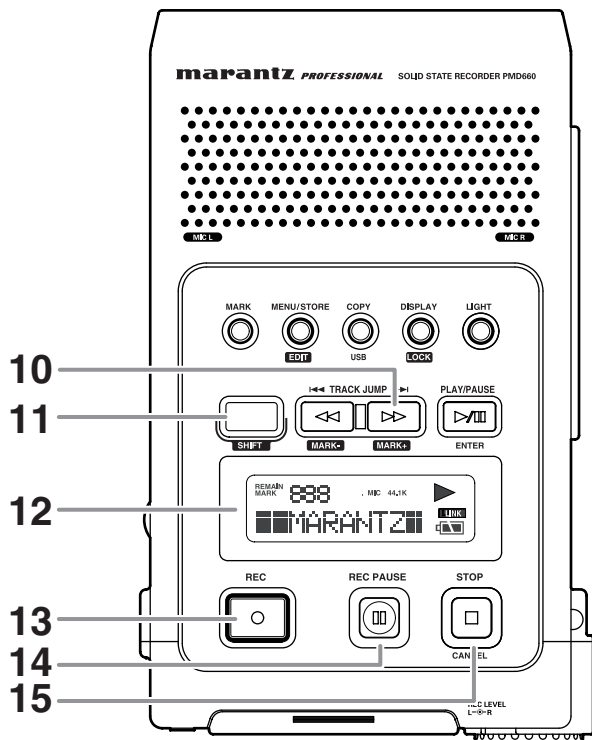

10. TRACK JUMP ►► / ►► / MARK+ button

- **TRACK JUMP ►►**

During playback, push to jump to the next track.

If pushed while playing, the last track jumps to the first track on the CF card.

- ►►

- During playback, push and hold the ►► button to "fast forward" and do a 2X speed audible search in the forward direction. Release to return to normal forward playback.

- During play - pause, push and hold the ►► button to fast forward quickly. The fast forward is at 10X speed for three seconds, then it automatically speeds up to 140x speed.

Notes:

If the ►► button is held past the end of a track, the fast forward will continue into the next track.

During Edit menu and Menu functions, push the ►► button to increment a parameter in the + direction.

- **MARK+**

From Stop, push and hold the SHIFT button while pushing the Mark+ button to tab through the EDL marks on the CF card.

To start playback from the displayed EDL Mark, push the PLAY/PAUSE button.

11. **SHIFT button**

Push and hold the SHIFT button while you push other buttons (white labels) to activate alternate functions.

12. **Display**

Labels, icons and alphanumeric messages on the display communicate the status of PMD660.

13. **REC button**

From Stop, push to start recording.

From Record - pause, push to resume recording.

During recording, push to increment the track (start a new audio file), if "Manual Trk" is turned on in the Preset menu.

14. **REC PAUSE button**

From Stop, push to enter record - pause. This allows you to check your record level prior to recording.

During recording, push to pause.

The REC indicator will flash when paused.

15. **STOP / CANCEL button**

• **STOP**

During recording, push to stop recording and end the track (file).

During playback, push to stop playback and end the playback session.

When you resume, playback starts at the beginning of the current track.

• **CANCEL**

During menu operations, push to cancel all entries made and return to stop mode.

Front side

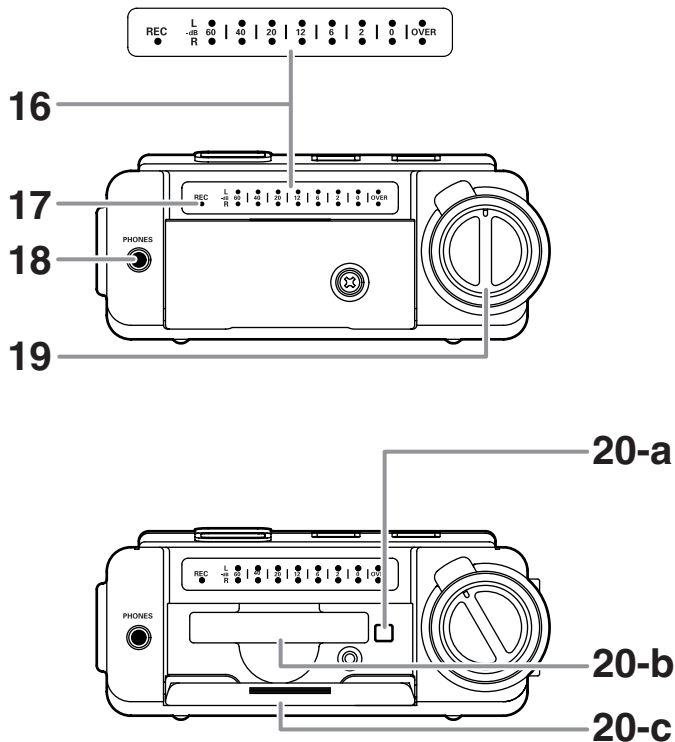

16. Level meter

The louder the sound input to the recorder on the Left/Right channel, the more LED lights are displayed. When the "Meter Mode" of preset menu is "Peak Only", only a peak level is displayed. (page 52)

17. REC indicator

Red indicator light is lit and steady during Record and flashing during Record pause.

18. PHONES jack

Stereo headphones are plugged into this jack. Set "Output" of the preset menu to SP/HP (See Page 44).

19. REC LEVEL controls

Turn to adjust the record level when the "LevelCont" of preset menu is "Manual".

The inside control (Right channel) and outside control (Left channel) turn together, unless you hold one while turning the other.

The optimum record level is when the level meter goes as close to 0dB as possible but does not go OVER.

20. CF card compartment

Pull the card door open to access the CF card.

20-a. Card eject button

20-b. CF card slot

20-c. CF card door

Left / Right side

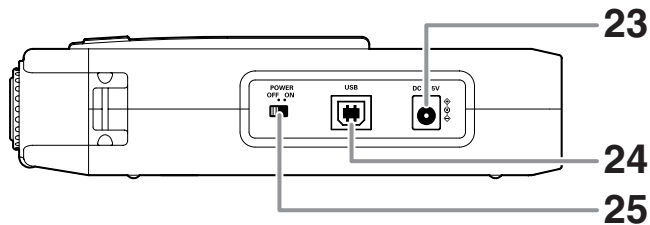
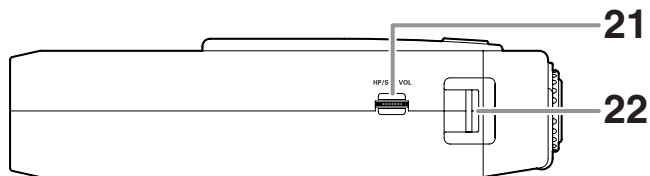

21. HP/SPK VOL control

Turn to adjust the volume of headphones plugged into the PHONE jack or the built-in speaker. Audio on the built-in speaker is automatically interrupted when recording with the internal microphone.

22. Carry strap shaft

Attach the supplied carry strap here.

23. DC IN jack

Plug the supplied AC adapter in this jack.

The power supplied is 2.0A at 5V DC.

The PMD660 automatically switches to adapter power if it was running on battery power. If AC power is interrupted by a power outage or unplugging the adapter, the PMD660 automatically switches to battery power.

24. USB port

Plug the supplied USB cable in this port and connect the other end to your computer.

25. POWER switch

Slide to turn Power on or off.

Rear side

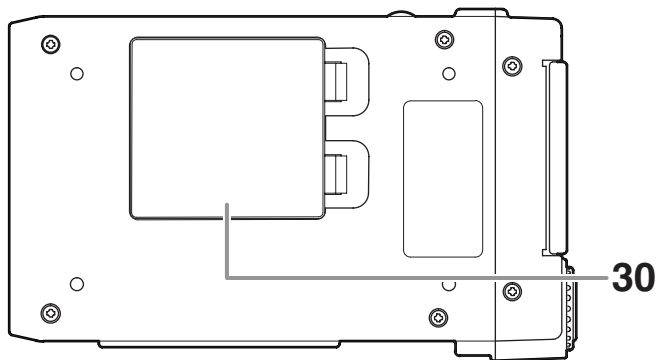
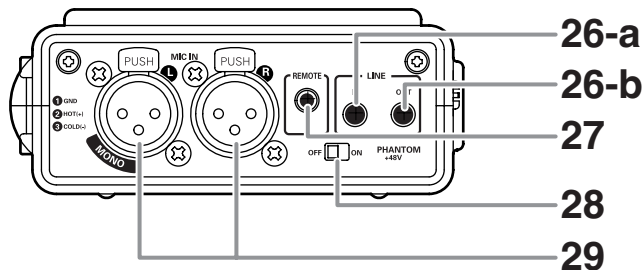

26. LINE IN/OUT jack

Plug external line level audio devices in this jack.

a. LINE IN

Plug stereo audio cable in this jack to record from the output of an external unit.

b. LINE OUT

Plug stereo audio cable in this jack to connect to the input of an amplifier or other external unit..

Set “Output” of the preset menu to LINE (See Page 44).

27. REMOTE jack

This jack accepts the optional wired remote Marantz model RC600PMD. Model RC600PMD connects via a TRRS (Tip Ring Ring Sleeve) connector.

Model RC600PMD permits:

- Starting recording (Same as the REC button).
- Pausing recording (Same as the REC PAUSE button).
- Adding EDL marks (Same as the MARK button).

28. PHANTOM power switch

Switch to on to provide +48V of power for a condenser microphone(s).

29. MIC IN jacks

Plug external microphones in the MIC IN jacks. For mono recording, use the Left jack.

30. Battery compartment

Pick and pull to open the Battery compartment.

Display

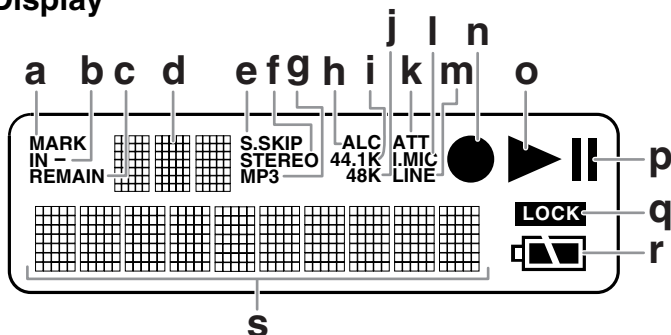

a. MARK

The MARK label appears when the number displayed on the upper alphanumeric display refers to EDL marks.

b. IN-

The IN- label appears when the beginning (start point) of Copy segment function has been set.

c. REMAIN

The REMAIN label appears to indicate remaining time.

d. Upper alphanumeric display

Displays track number, number of tracks on CF card, EDL mark number, number of EDL's on CF card.

e. S.SKIP

The S.SKIP label appears when Silent Skip is enabled.

f. STEREO

The STEREO label appears when the recording channel is stereo.

g. MP3

The MP3 label appears when the audio file is MP3.

h. ALC

The ALC label appears when the PMD660 automatically responds to changes in recording input level.

i. 44.1K

The 44.1K label appears when the recording audio wave(s) is 44,100 samples per second.

j. 48K

The 48K label appears when the recording audio wave(s) is 48,000 samples per second.

k. ATT

The ATT label appears when input from a microphone(s) connected to the MIC IN jacks is cut by -20dB.

l. I.MIC/MIC

The I.MIC label appears when input selected for recording is the internal microphone. The MIC label appears when external microphone(s) is selected.

m. LINE

The LINE label appears when input selected for recording is the LINE IN jack.

n. Record

The Record symbol appears when the PMD660 is in record mode. It appears with the Play symbol when recording and appears flashing when in record - pause.

o. Play

The Play symbol appears when the PMD660 is in playback, playback pause, recording, or recording pause.

p. Pause

The Pause symbol appears when the PMD660 is in playback pause or recording pause.

q. LOCK

The Lock symbol appears when the PMD660 is in key lock.

r. Battery

The Battery symbol appears in most displays to indicate battery usage.

s. Lower alphanumeric display

Displays a variety of information including remaining time, clock time, menu settings, etc.

Basic operation

The PMD660 comes factory preset for recording voice using its built-in (internal) microphone. These are settings for recording a meeting, not settings for recording a vocal performance.

1. Unpack the AC adapter and the PMD660.
 - a. Plug AC adapter into 100 - 240VAC power.
 - b. Plug the adapter jack into the PMD660 at DC IN.

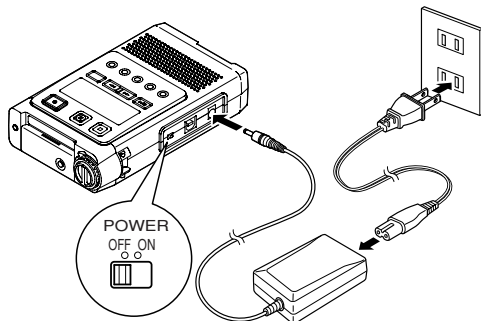

2. Install a CF card.
See page 17 for installing a CF card.

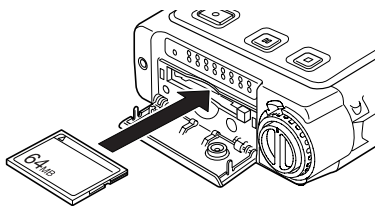

Note: Outside of the USA, a CF card is not included.

3. Slide the POWER switch to turn on.

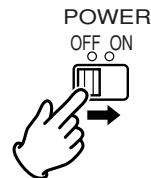

- a. A full display will appear. Wait for the PMD660 to initialize.

Loading

- b. The display will change to this display for a newly formatted CF card.



CF cards

The PMD660 records onto various types of CF (Compact Flash) cards.

Please refer to the Marantz Professional web site at www.d-mpro.com for what kinds of media are recommended.

To insert a CF card

a. Open the CF card door.

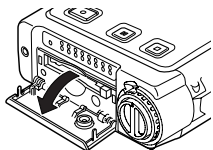

b. Fully insert the CF card.

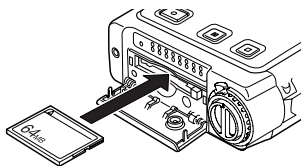

c. Close the CF card door.

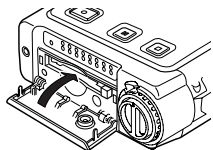

Note:

If the CF card door won't latch, check that the Card eject button is in the click in position.

To eject a CF card

a. Slide the POWER switch to turn off.



b. Open the CF card door.

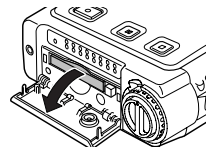

c. Push the card eject button so it is in click out position.

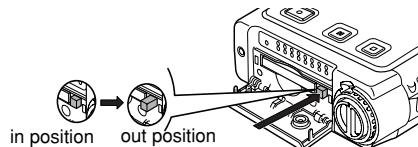

d. Push the Card eject button and remove the CF card.

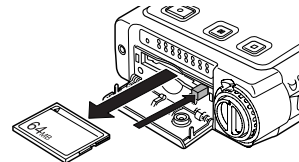

- If the CF card door opens while power is on, "Door Open" is displayed and the PMD660 turns off.
- If recording is in progress, opening the CF card door automatically stops recording and writes critical track information to properly close the file before powering off.

CF card security

The supplied CF card compartment security screw requires using a small Phillips screwdriver to open the CF card compartment door. This reduces the possibility that the CF card will be misplaced or stolen.

- a. Remove the plastic pin and then the retainer.

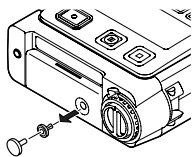

- b. Insert the screw.

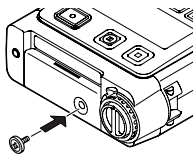

- c. Tighten the screw with a small Phillips screwdriver tight enough so the screw cannot be removed with a fingernail.

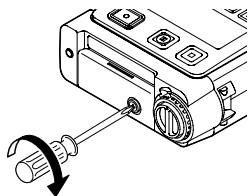

CF card Format

Formatting a CF card **erases all audio files on the CF card** and prepares it for use in the PMD660. If the CF card is formatted other than FAT16 or FAT32 (FAT=file allocation table), please format in your computer.

Setup the "**Format**" in the Edit menu. (page 28)

Recording

Connection Diagram

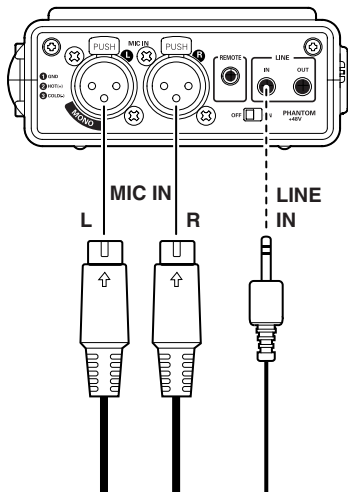

Recording Procedure

1. Slide the POWER switch to turn on.

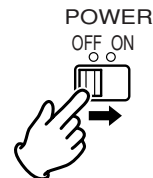

2. Push the REC button to begin recording.



The Rec indicator will be lit and steady while recording. The display will show the information display of recording. (page 40)

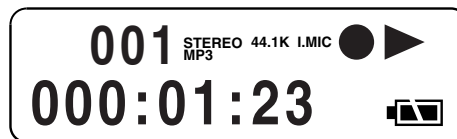

3. Push the REC PAUSE button to pause recording.



4. Push the STOP button to stop recording and end the track (close the audio file).

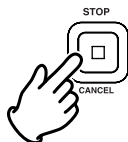

The display will show the information display of stop.



Audio inputs for recording

Audio inputs for recording are selected using the Input Menu.

Channel : Stereo

Display	Input Menu
I. MIC	Internal Mic Recording (Stereo, L/R ch)
MIC	External Mic Recording (Stereo, L/R ch)
LINE	LINE Recording (Stereo, L/R ch)

Channel : Mono

Display	Input Menu
I. MIC	Internal Mic Recording (Mono, L ch)
MIC	External Mic Recording (Mono, L ch)
LINE	LINE Recording (Mono, L ch)

Setup the "Input" (page 44) and "RecChannel" (page 46) of the preset menu.

Recording Format parameters

The PMD660 can record in several compression algorithms.

- Compressed recording using MPEG1 Layer III (MP3) mono and stereo.
- Uncompressed recording using 16-bit linear Pulse Code Modulation (PCM).

Channel : Stereo

RecFormat	Sampling Rate	Bitrate	File Extension
MP3-44.1kHz	44.1kHz	128 kbps	.mp3
MP3-48kHz	48kHz	128 kbps	.mp3
PCM-44.1kHz	44.1kHz	1412 kbps	.wav
PCM-48kHz	48kHz	1536 kbps	.wav

Channel : Mono

RecFormat	Sampling Rate	Bitrate	File Extension
MP3-44.1kHz	44.1kHz	64 kbps	.mp3
MP3-48kHz	48kHz	64 kbps	.mp3
PCM-44.1kHz	44.1kHz	705.5 kbps	.wav
PCM-48kHz	48kHz	768 kbps	.wav

The record file of PCM is BWF (Broadcast Wave Format).
(Europe only)

Setup the "Rec Format" and "RecChannel" of the preset menu. (page 46)

Recording time chart

All times are approximated record times.

Different media manufacturers allow more or less space for error correction and the like on their respective products.

	bit rate	64 kbps	128 kbps
	.mp3	mono	stereo
CARD SIZE	32 MB	1:06	0:33
	64 MB	2:13	1:06
	128 MB	4:26	2:13
	256 MB	8:52	4:26
	340 MB	11:46	5:53
	512 MB	17:44	8:52
	(1 GB) 1024 MB	35:28	17:44
	(2GB) 2048MB	70:56	35:28
	(4GB) 4096MB	141:52	70:56

	fs	44.1 kHz	
	PCM	mono	stereo
CARD SIZE	32 MB	0:06	0:03
	64 MB	0:12	0:06
	128 MB	0:24	0:12
	256 MB	0:48	0:24
	340 MB	1:04	0:32
	512 MB	1:36	0:48
	(1 GB) 1024 MB	3:13	1:36
	(2GB) 2048MB	6:27	3:13
	(4GB) 4096MB	12:54	6:27

	fs	48 kHz	
	PCM	mono	stereo
CARD SIZE	32 MB	0:05	0:02
	64 MB	0:11	0:05
	128 MB	0:22	0:11
	256 MB	0:44	0:22
	340 MB	0:59	0:29
	512 MB	1:28	0:44
	(1 GB) 1024 MB	2:57	1:28
	(2GB) 2048MB	5:55	2:57
	(4GB) 4096MB	11:51	5:55

Recording Level Control

The recording level control lets you select the type of input level control.

- At Manual, you control the input level with the REC LEVEL controls.

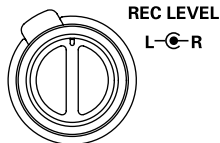
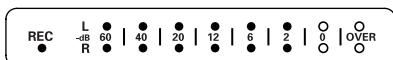

- The inside control(Right Channel) and outside control (Left Channel) turn together unless you hold one while turning the other.
- The optimum record level is when the level meter goes as close to 0dB as possible but does not go OVER.
- At ALC (Automatic Level Control), the PMD660 automatically responds to changes in input level.

Setup the "**LevelCont.**" of the preset menu. (page 51)

Microphone Attenuator

The microphone attenuation switch permits the direct use of microphones that differ in sensitivity.

- At 0dB, No microphone attenuation.
- At -20dB, Input from a microphone(s) connected to the MIC IN jacks is cut by -20dB.

Setup the "**Mic Atten.**" of the preset menu. (page 52)

Pre Record

When PreRecord is on and the PMD660 is in record pause, it 'listens to' the selected audio input(s) and continuously buffers 2 seconds of audio.

Then, when record is started, the PMD660 writes the previously buffered 2 seconds of audio to the card & continues to record from there.

Setup the "**PreRecord**" of the preset menu. (page 47)

Silent Skip (Automatic Pause Recording)

Silent Skip automatically pauses recording when there is a period of silence and resumes recording when sound resumes.

The Silent Skip Menu setting permits:

- Turning Silent Skip On or Off.
- Adjusting the margin sound level that defines silence in -60dB, -54dB, -38dB or -20dB.

Setup the "**Silent Skip**" of the preset menu. (page 50)

Add a Track manually

When Manual Trk (Manual Track incrementing) is On during recording, push the REC button to increment the track.

A new track is created at that point.

The continuity of sound is not guaranteed and depends on the speed of a card or the file size.

Setup the "**Manual Trk**" of the preset menu. (page 47)

Add a Track automatically

With Auto Trk(Automatic Track incrementing) on, a new track is begun automatically at specified intervals of recording time.

Automatic Track can be set to increment every 1, 5, 10, 15 or 30 minutes, or every 1, 2, 6, 8, 12 or 24 hours.

Automatic Track makes finding a particular point in a recording easier. For example, if a new track begins every minute during playback, the Minute Track makes finding a particular passage easier because of the relationship between track numbers and time. During playback, you can select track 3 to play approximately the 3rd minute of recording. To go directly to the beginning of the 10th minute, select track 10, etc.

Track #	Recording time minutes:seconds
1.....	0:00 – 1:00
2.....	1:01 – 2:00
3.....	2:01 – 3:00

The continuity of sound is not guaranteed and depends on the speed of a card or the file size.

Setup the "**Auto Trk**" of the preset menu. (page 48)

Playback

Connection Diagram

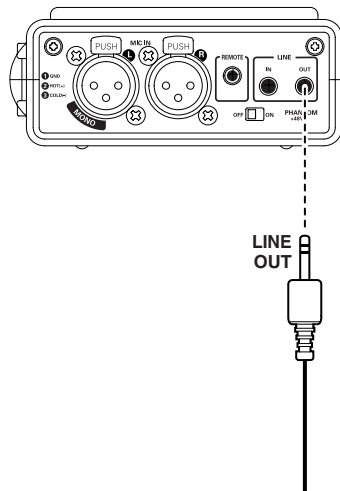

Playback Procedure

- Slide the POWER switch to ON.

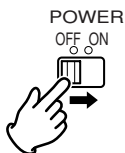

- Push the PLAY/PAUSE button to begin playback.



The PLAY indicator will be lit and steady while in playback.



- Push the PLAY/PAUSE button again to pause playback.
- Push the STOP button to stop playback.

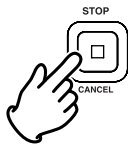

Track Access

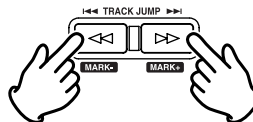

- TRACK JUMP ◀◀**
 During playback, push to jump to the previous track. If pushed while playing the first track, it jumps to the last track on the CF card.
- TRACK JUMP ▶▶**
 During playback, push to jump to the next track. If pushed while playing the last track, it jumps to the first track on the CF card.



Search

- ◀◀ TRACK**
 During play - pause, push and hold the ◀◀ button to rewind quickly. The rewind is at 10X speed for three seconds, then it automatically speeds up to 140X speed.
- JUMP ▶▶**
 During play - pause, push and hold the ▶▶ button to fast forward quickly. The fast forward is at 10X speed for three seconds, then it automatically speeds up to 140X speed.

Notes:

- If the ▶▶ button is held past the end of a track, the fast forward will continue into the next track.
- If the ◀◀ button is held past the beginning of a track, the rewind will continue into the previous track.

Audible Search

- 
 During playback, push and hold the ◀◀ button to "rewind" and do a 2X speed audible search in the reverse direction. Release to return to normal forward playback.
- 
 During playback, push and hold the ▶▶ button to "fast forward" and do a 2X speed audible search in the forward direction. Release to return to normal forward playback.

Audio outputs for playback

Audio outputs for playback are selected using the Output Menu. Selections are:

- The built-in speaker or headphones connected to the PHONES jack. (SP/HP)
- Analog audio devices such as an amplifier or other device connected to the LINE OUT jacks. (LINE)

Setup the "**Output**" of the preset menu. (page 44)

Note:

Sound cannot be output the LINE OUT and the SP/HP simultaneously.

EDL Mark

EDL (Edit Decision List) marks can be created during recording manually or automatically. EDL marks help you find specific points in the recording.

- The EDL marking system is proprietary to Marantz.
- During playback, you can instantly locate EDL marks.
- Up to 255 EDL marks can be added to a CF card.
- EDL marks are numbered consecutively starting at one.
- During recording, you can manually add an EDL mark by pushing the MARK button. EDL marks can also be added automatically.

Add an EDL mark manually

Push the MARK button to add an EDL Mark manually during pause, recording or playback.

During recording, adding an EDL Mark introduces an audible click in the recording when using the internal microphone.

Search the EDL mark

- 
 MARK+

From Stop or playback, push and hold the SHIFT button while pushing the Mark+ button to tab through the EDL marks on the CF card.

To start playback from the displayed EDL Mark, push the PLAY/PAUSE button .



MARK-

From Stop or playback, push and hold the SHIFT button while pushing the Mark- button to tab through the EDL marks on the CF card.

To start playback from the displayed EDL Mark, push the PLAY/PAUSE button .

Add an EDL mark automatically

The Auto Mark Menu item turns the automatic EDL mark feature Off or On.

See page 25 to manually add EDL marks.

- If Auto Mark is on and the machine is in record - pause, when recording is resumed a mark will be added.
- If Auto Mark is on and the PMD660 is recording audio below the sound threshold for more than three seconds, audio that crosses the threshold will cause a mark to be added.

The Auto Mark Menu setting permits:

- Turning Auto Mark On or Off.
- Adjusting the margin sound level that defines silence in -60dB, -54dB, -38dB or -20dB.

Setup the "**Auto Mark**" of the preset menu. (page 49)

Edit

Edit menu, accessed from stop by pushing and holding the SHIFT button then pushing the MENU/STORE EDIT button, lets you erase tracks, erase EDL marks and format the CF card.

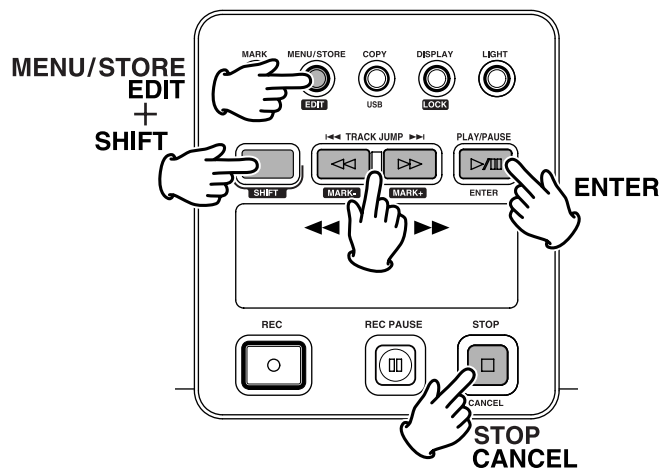

Edit mode includes:

1. Trk Erase
2. TrkMkErase
3. AllMkErase
4. Format

1. Trk Erase (How to erase tracks)

TrkErase lets you erase a selected track.

After identifying the track number you want to erase.

1. Select the Trk Erase Edit menu choice:
While in stop, push and hold the SHIFT button then push the MENU/STORE EDIT button.
"Trk Erase" will appear in the display.
2. Push the ENTER button.
The Display switches to track number flashing.
3. Push the the ◀◀ or ▶▶ button until the track number you want to erase is flashing.
4. Push the ENTER button.
"Executing" will be displayed until Trk Erase is finished.
Then "Completed" will be displayed.
 - Display returns to step 3 so you can erase another track.
5. Push the STOP/CANCEL button to cancel.

Note:

The related virtual track(s) and EDL marks associated with the erased track will also erase.

2. TrkMkErase

(How to erase all EDL marks within one track)

TrkMkErase lets you erase all of a track's EDL marks.

Decide on which track's EDL marks you want to erase.

1. Select the TrkMkErase Edit menu choice:
While in stop, push and hold the SHIFT button then push the MENU/STORE EDIT button.
"Trk Erase" will appear in the display.
2. Push the ◀◀ or ▶▶ button until "TrkMkErase" is displayed.
3. Push the ENTER button.
The Display switches to track number flashing.
4. Push the ◀◀ or ▶▶ button so the track number whose EDL marks you want to erase is flashing.
5. Push the ENTER button.
"Executing" will be displayed until TrkMkErase is finished.
Then, "Completed" will be displayed
 - Display returns to step 4 so you can erase another track's EDL marks.
6. Push the STOP/CANCEL button to cancel.

Note:

EDL marks will automatically be renumbered.

3. AllMkErase (How to erase all EDL marks)

AllMkErase lets you erase all EDL marks on the CF card.

1. Select the AllMkErase Edit menu choice:
While in stop, push and hold the SHIFT button then push the MENU/STORE EDIT button.
"Trk Erase" will appear in the display.
2. Push the ◀◀ or ▶▶ button until "AllMkErase" is displayed.
3. Push the ENTER button.
The Display switches to "All" flashing.
4. Push the ENTER button.
"Executing" will be displayed until AllMkErase is finished.
Then "Completed" will be displayed.
The PMD660 and display return to stop mode.
5. Push the STOP/CANCEL button to cancel.

4. Format (How to format a CF card)

Format lets you **erase all audio files on the CF card** and prepares it for use in the PMD660.

If the CF card is formatted other than FAT16 or FAT32 (FAT=file allocation table), please format in your computer.

1. Select the Format Edit menu choice:
While in stop, push and hold the SHIFT button then push the MENU/STORE EDIT button.
"Trk Erase" will appear in the display.
2. Push the ◀◀ or ▶▶ button until "Format" is displayed.
3. Push the ENTER button.
The Display switches to "OK?" flashing.
4. Push the ENTER button.
"Executing" will be displayed until Format is finished.
Then "Completed" will be displayed.
The PMD660 and display return to stop mode.
5. Push the STOP/CANCEL button to cancel.

Virtual Track and Copy Segment

The Marantz Professional PMD660 is the first solid state recorder to incorporate new file editing features like Virtual Track and Copy Segment. Designed with the field reporter in mind, they provide a host of quick and easy to use ways of locating and accessing segments of audio that everyone can utilize.

Virtual Track

Virtual Track allows you to set an In point and an Out point within a file (or across multiple files of the same RecFormat and RecChannel) for later, immediate access. Files marked as Virtual Tracks are stored in the PMD660 and can be accessed quickly by entering the PMD660 in Virtual Playback mode.

See Page 30, Creating a Virtual Track.

See Page 32, Entering Virtual Track Playback mode.

Note:

Because Virtual Tracks are really just location information stored on the card, creating Virtual Tracks requires practically no memory on your card reserving valuable space for actual recorded material.

Copy Segment

Copy Segment operates exactly like Virtual Track except, instead of storing In and Out points for immediate playback access, Copy Segment physically turns your “highlighted” section into a new and separate file, without destroying the original source file(s).

See Page 31, Using Copy Segment to create a new file.

Virtual Track Edit mode

In addition, Virtual Playback mode has an edit menu that allows you to turn one Virtual Track into a new file, all Virtual Tracks into new files, erase a Virtual Track, and erase all Virtual Tracks.

See Page 33, Virtual Track EDIT mode.

Creating a Virtual Track

1. During playback, push the COPY/USB button when the audio reaches your desired In Point.



“SetAs IN?” is displayed.



2. Push the PLAY/PAUSE button to store the In point.



“IN-” will flash in the display to indicate the In point has been stored and playback of the file resumes.



3. Continue to let the PMD660 play to your desired Out point, or use the standard transport controls like the **▶▶** or **▶▶▶** buttons to span greater time lengths.

4. When you have reached your desired Out point, push the COPY/USB button.



“SetAs OUT?” is displayed.



5. Push the PLAY/PAUSE button to store the Out point.

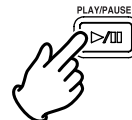

“StoreV. Tr?” is displayed.



6. Push the PLAY/PAUSE button to store your segment as a Virtual Track. “Executing” will be displayed momentarily, and then the display will read “Completed.” To playback your created Virtual Track, see page 32, Entering Virtual Playback.



Using Copy Segment to create a new file

1. During playback, push the COPY/USB button when the audio reaches your desired In Point.



“SetAs IN?” is displayed.



2. Push the PLAY/PAUSE button to store the In point.



“IN-” will flash in the display to indicate the In point has been stored and playback of the file resumes.



3. Continue to let the PMD660 play to your desired Out point, or use the standard transport controls like the **▶▶** or **▶▶▶** buttons to span greater time lengths.

4. When you have reached your desired Out point, push the COPY/USB button.



“SetAs OUT?” is displayed.



5. Push the PLAY/PAUSE button to store the Out point.



“StoreV. Tr?” is displayed.



6. Push the **◀◀** or **▶▶** button until the display reads “Copy SEG?”



7. Push the PLAY/PAUSE button to start the Copy process.



“Executing” will be shown on the display.



When the copy procedure is completed, the display will show “Completed” for 1 sec. and then returns to stop mode with your new file as the current track.



Notes:

- When a copy area spans across two or more tracks, a track is connected and copied.
- When the copy area spans across files of different RecFormat or RecChannel, it can not copy.
- The copy area can not exceed 80 minutes.
- When copying a PCM segment, processing time is real time.
- When copying an MP3 segment, processing time is at 8X speed.

Entering Virtual Playback mode

Now that you have created a Virtual Track, to play it back you must put the PMD660 into Virtual Track Playback mode.

1. From stop mode, push the COPY/USB button to enter Virtual Playback mode.



“V. Tr Play” will be shown on the display.



2. Push the PLAY/PAUSE button to play the first Virtual Track. If you have more than one Virtual Track, you can push the ◀◀ or ▶▶ button until the track you wish to play is displayed in the upper numeric display. Then push the PLAY/PAUSE button.

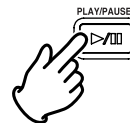

3. To exit Virtual Track Playback mode:
If a Virtual Track is playing press the STOP button twice.
If the PMD660 is in Virtual Track Playback mode and stopped, simply push the STOP button once.

Virtual Track EDIT mode

Just like regular playback mode, Virtual track has its own EDIT mode. Within this EDIT mode, you have the ability to turn one of your Virtual tracks into a new file, all Virtual Tracks into new files, erase a Virtual Track, and erase all Virtual Tracks.

1. To enter Virtual Track EDIT mode, push and hold the SHIFT button and then push the MENU/STORE/EDIT button, while in Virtual Track Playback mode.

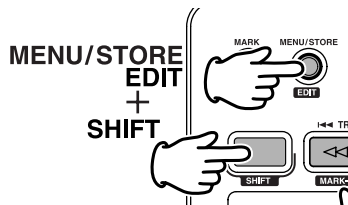

See next Frame, How to convert a Virtual Track to a new file.
See Page 34, How to convert all Virtual Tracks to new files.
See Page 34, How to erase a Virtual Track.
See Page 35, How to erase all Virtual Tracks.

Copy SEG?

[How to convert a Virtual Track to a new file]

When in Virtual Track EDIT mode, “Copy SEG?” lets you copy a single Virtual Track to a new file.

After indentifying the track to copy:

1. Select the “Copy SEG?” Edit menu choice:
While in Virtual Track Play mode, push and hold the SHIFT button and then push the MENU/STORE/EDIT button. “Copy SEG?” will appear in the display.
2. Push the ENTER button.
The display switches to the Track number blinking in the upper numeric display.
3. Push the ◀◀ or ▶▶ button until the Track number you want to copy is flashing.
4. Push the ENTER button.
“Executing” will be displayed while the copy process works. Then “Completed” will be displayed for one second. The display returns to step 3 so you can erase another track.
5. Push the STOP/CANCEL button to cancel.

Copy SEG A? [How to convert all Virtual Tracks to new files]

When in Virtual Track EDIT mode, “Copy SEG A?” lets you copy all of your Virtual Tracks to new files.

1. Select the “Copy SEG A?” Edit menu choice:
While in Virtual Track Play mode, push and hold the SHIFT button and then push the MENU/STORE/EDIT button. “Copy SEG?” will appear in the display.
2. Push the ◀◀ or ▶▶ button until the display reads “Copy SEG A?”
3. Push the ENTER button.
The display switches “All” blinking in the upper numeric display.
4. Push the ENTER button.
“Executing” will be displayed while the copy process works. Then “Completed” will be displayed for one second. The PMD660 and display returns to stop mode.
5. Push the STOP/CANCEL button to cancel.

VT Erase? [How to erase a Virtual Track]

When in Virtual Track EDIT mode, “VT Erase?” lets you erase a single Virtual Track.

After indentifying the track to erase:

1. Select the “VT Erase?” Edit menu choice:
While in Virtual Track Play mode, push and hold the SHIFT button and then push the MENU/STORE/EDIT button. “Copy SEG?” will appear in the display.
2. Push the ◀◀ or ▶▶ button until “VT Erase?” is displayed.
3. Push the ENTER button.
The display switches to the Track number blinking in the upper numeric display.
4. Push the ◀◀ or ▶▶ button until the Track number you want to copy is flashing.
5. Push the ENTER button.
“Executing” will be displayed while the copy process works. Then “Completed” will be displayed for one second. The display returns to step 4 so you can erase another track.
6. Push the STOP/CANCEL button to cancel.

AVT Erase?

[How to erase all Virtual Tracks]

When in Virtual Track EDIT mode, “AVT Erase?” lets you erase all Virtual Tracks from memory.

1. Select the “AVT Erase?” Edit menu choice:
While in Virtual Track Play mode, push and hold the SHIFT button and then push the MENU/STORE/EDIT button.
“Copy SEG?” will appear in the display.
2. Push the ◀◀ or ▶▶ button until “AVT Erase?” is displayed.
3. Push the ENTER button.
The display switches to the “All” blinking in the upper numeric display.
4. Push the ENTER button.
“Executing” will be displayed while the copy process works.
Then “Completed” will be displayed for one second.
The PMD660 and display returns to stop mode.
5. Push the STOP/CANCEL button to cancel.

USB mode

The PMD660 records directly onto CF cards. Recordings can then be transferred to your desktop or laptop computer by removing the CF card from the PMD660, or by connecting the PMD660, to your computer via the USB port. Audio recorded in the popular MP3 compression format is directly available for intranet or internet file sharing.

Computer compatible

On your computer you can then:

- log and archive audio files
- play audio files

Save audio files to:

- your hard drive
 - a floppy
 - a CD-R disc
-
- post streaming audio files on your web site
 - use software and your computer to transcribe digital recordings
 - An editing program (Marantz Professional's PMD Edit application software, available from Marantz Professional for PC users) lets you convert and edit audio files that were recorded on the PMD660.

How to connect via the USB port

The CF card in the PMD660 appears as an external drive on a connected computer.

1. Connect the cable to the PMD660 and your computer.

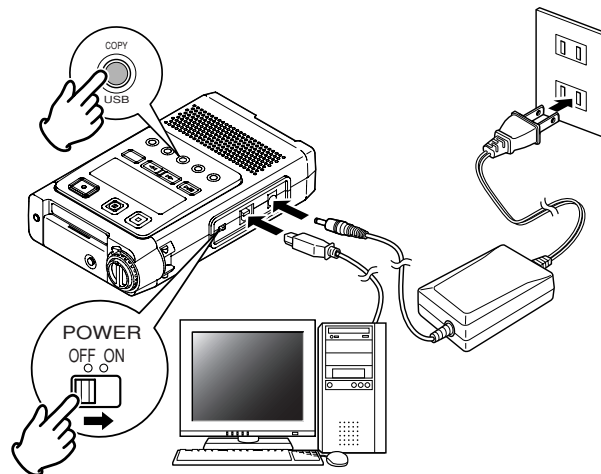

2. From power off, push and hold the COPY/USB button while turning on the PMD660's POWER switch. "USB" is displayed.

USB

- The PMD660 cannot be used while in USB mode.
- The CF card in the PMD660 appears as a removable device on your computer.
- The audio files are in a folder that is named MPGLANG1.
- Power off and back on to resume recording or playback on the PMD660.

Notes:

- If the PMD660 is not connected to the AC adapter, "Need DC IN" is displayed.
- The USB connection can only be made active when the PMD660 is off (neither during recording nor playback).

CAUTION:

- Only copy audio files (tracks) to other volumes.
- Do not modify or delete the EDL file.
- If the EDL and Virtual Track file is missing or damaged PMD660 will not be able to recognize EDL marks and Virtual Tracks.
- Do not remove a CF card during USB mode. Data and the CF card can be damaged.
- See the enclosed CD-ROM for PMDEdit demo software for computer audio file manipulation.
- PMDEdit is a full featured software suite designed for Marantz Professional digital recorders available for purchase at www.d-mpro.com.

Diagram of file structure

A file titled PMD660 will appear on your computer. EDL, Virtual Track and a folder (directory) titled MPGLANG1 will also appear.

Files within the MPGLANG1 folder are numbered from aaaaa001 through the number of tracks recorded to a maximum of aaaaa999.

("aaaaa" depends on the Machine ID parameter).

The file extension will be .mp3 or .wav depending on the "Rec Format" parameter that is set for the recording.

```

Root----PMD660.EDL
      |--PMD660.CPY
      |--MPGLANG1
          |--aaaaa001.MP3
          |--aaaaa002.MP3
          |--aaaaa003.MP3
  
```

Changes made to file names or structures on your computer will prevent file recognition and playback in the PMD660.

Machine ID

An audio track (file) has Machine ID information. This information is included in a file name. For example, if the Machine ID is "aaaaa", the first file is numbered "aaaaa001.wav" or "aaaaa001.mp3".

Default setting is MZ000.

Setup the "**Machine ID**" of the preset menu. (page 54)

Additional Functions

Battery

Battery setup

The PMD660 operates on 4 standard AA size Alkaline, or Ni-MH batteries.

Setup the "**Battery**" of the preset menu.
(page 53)

Battery indicator

The Battery symbol appears in most displays to indicate battery life.



indicates that the battery is fully charged.



indicates that the battery, is half charged.
Record or playback time is available.



indicates that the battery charge is getting low. Battery charge is required as there is little record or playback time available.

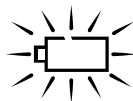

flashing indicates that the battery is very low!

- If Beep is set to On, the PMD660 will beep.
- If the PMD660 continues to operate, it will automatically shut down.
- If recording, it will write track information, stop recording and power off.
- If in playback, it will stop playback and power off.

Auto power off

If the PMD660 is not operated for 15 minutes during stop or play pause, power can be automatically shut off to conserve battery life.

Setup the "**AutoPowOff**" of the preset menu. (page 53)

Beep Alarm

When battery charge can provide no more Power and Beep is set to On, the battery indicator will flash and the PMD660 will beep and power off.

Setup the "**Beep**" of the preset menu. (page 54)

Key lock

The key lock secures the PMD660 in the state it is in during Record, Playback or Stop. Push and hold the SHIFT button while pushing the DISPLAY/ LOCK button to turn KEY LOCK on. All buttons and functions will cease to operate with the exception of the LIGHT button.

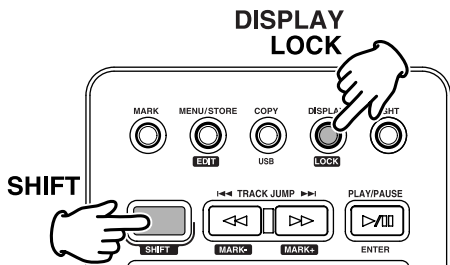

Set Date and Time

The date and time are written on each audio track (file) when the track is started. When an audio track is viewed on a computer, this date and time appears as when the file was 'created'. (US date form is illustrated.)

Setup the **"Date/Time"** of the preset menu. (page 45)

LED level meter

The Level LED lets you select the type of level meters.

- At Normal, the level meter(s) display is normal.
- At Peak Only, the level meter(s) displays only a peak level.

Setup the **"Meter Mode"** of the preset menu. (page 52)

Phantom Power

Switch Phantom to ON to provide +48V of power for a condenser microphone(s).

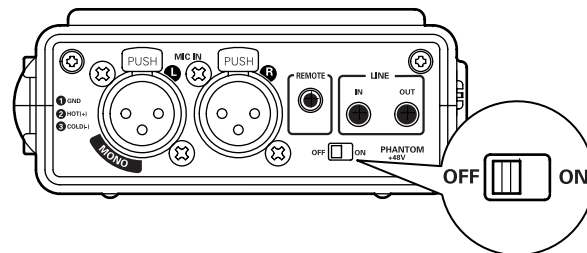

ON: +48V is supplied to power condenser microphone(s).
OFF: No microphone power is supplied.

It takes a few seconds to begin recording audio after switching ON/OFF.

Microphone recommendations

Professional condenser microphone(s) (which require additional power from either the PMD660's phantom power or from another source) are recommended because they provide greater sensitivity and higher quality audio recording.

Dynamic microphone(s) can be used, but they do not yield optimum audio quality recordings in some applications.

Consult with your local dealer to select the appropriate microphone(s) for your specific application. In many cases, they can demonstrate the various performances and characteristics of microphones for your use.

Display

Push the DISPLAY / LOCK button to alternate information displays.

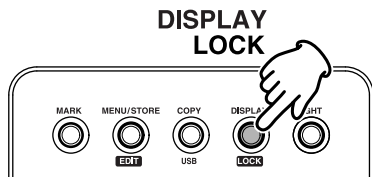

Displays are slightly different in Stop, Record and Play.

• During Stop:

- Remaining record time for the CF card (Default display)
- ↓
- Total EDL marks on CF card.
- ↓
- Current clock date
- ↓
- Current clock time
- ↓
- Remaining record time for the CF card (Default display)

• During Record:

- Elapsed record time of the current track (Default display)
- ↓
- Remaining record time for the CF card
- ↓
- Recording date information
- ↓
- Recording time information
- ↓
- Recording track name (Machine ID) information
- ↓
- Elapsed record time of the current track (Default display)

• During Playback:

- Elapsed play time of the current track (Default display)
- ↓
- Remaining playing time on the current track
- ↓
- Recorded date information
- ↓
- Recorded time information
- ↓
- Playing track name (Machine ID) information
- ↓
- Elapsed play time of the current track (Default display)

Preset Setup

Presets lets you set or change recording and playback parameters, such as changing inputs and setting the Date and Time.

Three menu selectable Presets make it easy to switch between your commonly used input, recording format and other menu selections.

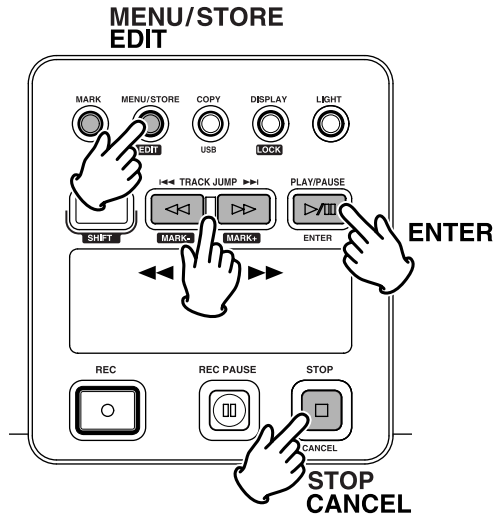

General Menu procedure

1. With the PMD660 at Stop, Push the MENU/STORE EDIT button.
2. Push the ◀◀ or ▶▶ button to choose the Preset number.
3. When displayed, push the ENTER button to select that Preset number choice.
4. Push the ◀◀ or ▶▶ button to tab through the sub menu display.
5. When the desired parameter or value is displayed and flashing, push the ENTER button to select it.
6. Repeat steps 2-5 as desired.
7. When finished, push the MENU/STORE EDIT button to store your changes, or push the STOP/CANCEL button to cancel them.

Preset defaults

The default Menu settings for Preset 1, 2 and 3 can be restored by the Default Menu choice. (pages 42 and 43.)

Table of Preset defaults (USA)

Display	Selection range	Default Setting		
		Preset1	Preset2	Preset3
1. Input	INT MIC/ MIC/ LINE	INT MIC	MIC	MIC
2. Output	LINE, SP/HP	SP/HP	SP/HP	SP/HP
3. Date/Time	2004 - 2099 Jan - Dec 1 - 31 AM/PM 00:00 - 11:59			
4. Rec Format	MP3-44.1K/ MP3-48K/ PCM-44.1K/ PCM-48K	MP3-44.1K	MP3-44.1K	PCM-48K
5. RecChannel	Stereo/Mono	Stereo	Stereo	Stereo
6. PreRecord	On/Off	On	On	Off
7. Manual Trk	On/Off	On	On	On
8. Auto Trk	Off/1/5/10/15/30min, 1/2/6/8/12/24 hrs	5min	Off	Off
9. Auto Mark	On/Off -60/-54/-38/-20dB	Off -38dB	Off -38dB	Off -38dB
10. Silent Skip	On/Off -60/-54/-38/-20dB	Off -38dB	Off -38dB	Off -38dB
11. LevelCont.	Manual/ALC	ALC	Manual	Manual
12. Meter Mode	Normal/Peak Only	Normal	Normal	Normal
13. Mic Atten.	0/-20dB	0dB	0dB	0dB
14. AutoPowoff	On/Off	On	On	On
15. Battery	Alkaline/NiMH	Alkaline	Alkaline	Alkaline
16. Beep	On/Off	On	On	On
17. Machine ID	5-digit ASCII code	MZ000	MZ000	MZ000
18. Default	---			
19. Version	---			
Application:		Meeting compressed	Music compressed	Highest Quality Uncompressed

Table of Preset defaults (Europe)

Display	Selection range	Default Setting		
		Preset1	Preset2	Preset3
1. Input	INT MIC/ MIC/ LINE	INT MIC	MIC	INT MIC
2. Output	LINE, SP/HP	SP/HP	SP/HP	SP/HP
3. Data/Time	2004 - 2099 Jan - Dec 1 - 31 00:00 - 23:59			
4. RecFormat	MP3-44.1K/ MP3-48K/ PCM-44.1K/ PCM-48K	PCM-44.1K	PCM-48K	MP3-44.1K
5. RecChannel	Stereo/Mono	Stereo	Stereo	Stereo
6. PreRecord	On/Off	On	On	On
7. Manual Trk	On/Off	On	On	On
8. Auto Trk	Off/1/5/10/15/30min, 1/2/6/8/12/24 hrs	Off	Off	Off
9. Auto Mark	On/Off -60/-54/-38/-20dB	Off -38dB	Off -38dB	Off -38dB
10. Silent Skip	On/Off -60/-54/-38/-20dB	Off -38dB	Off -38dB	Off -38dB
11. LevelCont.	Manual/ALC	Manual	Manual	Manual
12. Meter Mode	Normal/Peak Only	Normal	Normal	Normal
13. Mic Atten.	0/-20dB	0dB	0dB	0dB
14. AutoPowoff	On/Off	On	On	On
15. Battery	Alkaline/NiMH	Alkaline	Alkaline	Alkaline
16. Beep	On/Off	On	On	On
17. Machine ID	5-digit ASCII code	MZ000	MZ000	MZ000
18. Default	---			
19. Version	---			
Application:		High Quality Uncompressed	Highest Quality Uncompressed	Music Compressed

1. Input (How to select input(s) for recording)

Audio input(s) for recording are selected using the Input Menu.

1. From stop, push the MENU/STORE EDIT button.
2. Push the ◀◀ or ▶▶ button to select Preset 1, 2 or 3.
3. Push the ENTER button to accept the selected Preset.
4. Push the ◀◀ or ▶▶ button until Input is displayed.
5. Push the ENTER button while Input is displayed.
The input choice(INT MIC, MIC or LINE) is flashing.
6. Push the ◀◀ or ▶▶ button to tab through the input choices.
7. When correct, push the ENTER button.
Display returns to Input.
8. Push the ◀◀ or ▶▶ button to select other Menu choices for editing. When editing the Preset is complete, push the MENU/STORE EDIT button to store the changes, or push the STOP/CANCEL button to exit Menu mode without making any changes.
9. Display returns to stop mode.

Notes:

When you choose the INT MIC input, the I.MIC label is displayed. When you choose the MIC input, the MIC label is displayed. When you choose the LINE input, the LINE label is displayed.

The PMD660 records only from the selected input. For example, if the input selected is LINE and no input source is connected to the LINE IN jacks, the PMD660 will record silence. Watch the level meters while in record pause. If the level stays at one display bar, check for the proper input selection.

2. Output (How to select output for playback)

Audio output for playback is selected using the Output Menu.

1. From stop, push the MENU/STORE EDIT button.
2. Push the ◀◀ or ▶▶ button to select Preset 1, 2 or 3.
3. Push the ENTER button to accept the selected Preset.
4. Push the ◀◀ or ▶▶ button until Output is displayed.
5. Push the ENTER button while Output is displayed.
The output choice(LINE or SP/HP) is flashing.
6. Push the ◀◀ or ▶▶ button to tab through the output choices.
7. When correct, push the ENTER button.
Display returns to Output.
8. Push the ◀◀ or ▶▶ button to select other Menu choices for editing. When editing the Preset is complete, push the MENU/STORE EDIT button to store the changes, or push the STOP/CANCEL button to exit Menu mode without making any changes.
9. Display returns to stop mode.

Notes:

The PMD660 plays back only through the selected output. For example, if the output selected is LINE, no sound output is available in the speaker or headphones (SP/HP) or vice versa.

3. Date/Time (How to set or change the Date and Time)

The date and time are written on each audio track(file) when the track is started. When an audio track is viewed on a computer, this date and time appears as when the file was 'created'.(US date form is illustrated.)

1. From stop, push the MENU/STORE EDIT button.
2. Push the ◀◀ or ▶▶ button to select Preset 1, 2 or 3.
3. Push the ENTER button to accept the selected Preset.
4. Push the ◀◀ or ▶▶ button so Date/Time is displayed.
5. Push the ENTER button while Date/Time is displayed.
The Date and time information will be displayed with the month flashing. (Europe : the day flashing)
6. Push the ◀◀ or ▶▶ button until the current month is displayed.
7. Push the ENTER button to confirm the month.
The day will be flashing. (Europe : the month flashing)
8. Push the ◀◀ or ▶▶ button until the current day is displayed.
9. Push the ENTER button to confirm the day.
The year will be flashing.
10. Push the ◀◀ or ▶▶ button until the current year is displayed.
11. Push the ENTER button to confirm the year.
The hour will be flashing.
12. Push the ◀◀ or ▶▶ button until the current hour is displayed.
13. Push the ENTER button to confirm the hour.
The minute will be flashing.
14. Push the ◀◀ or ▶▶ button until the current minute is displayed.

15. Push the ENTER button to confirm the minute.
16. Date/Time will be displayed.
17. If you are finished making Menu changes to the Preset, push the MENU/STORE EDIT button to save your changes.
(or push the STOP/CANCEL button to cancel all changes)
18. Display returns to stop mode.

Note:

The Date/Time setting will remain for about 5 years if the PMD660 is not plugged in.
Date/Time setting applies to all three presets.

4. Rec Format

(How to set or change the Rec Format parameters)

The PMD660 can record in several compression algorithms. See explanation and chart below.

- First, determine the input connection you want to record from; INT MIC, MIC, or LINE.
- Second, set the Preset Menu Input choice to correspond with the connection.

RecChannel in menu	Rec Format in menu	bit rate	file extensions
Stereo	PCM-44.1K	1412k	.wav
	PCM-48K	1536k	.wav
	MP3-44.1K	128k	.mp3
	MP3-48K	128k	.mp3
Mono	PCM-44.1K	705.6k	.wav
	PCM-48K	768k	.wav
	MP3-44.1K	64k	.mp3
	MP3-48K	64k	.mp3

1. From stop, push the MENU/STORE EDIT button.
2. Push the ◀◀ or ▶▶ button to select Preset 1, 2 or 3.
3. Push the ENTER button to accept the selected Preset.
4. Push the ◀◀ or ▶▶ button so Rec Format is displayed.
5. Push the ENTER button while Rec Format is displayed and flashing. The Rec Format choice(PCM 44.1K, PCM-48K, MP3-44.1K or MP3-48K) is flashing.
6. Push the ◀◀ or ▶▶ button to tab through the Rec Format choices.
7. When correct, push the ENTER button. Display returns to Rec Format.

8. Push the ◀◀ or ▶▶ button to select other Menu choices for editing. When editing the Preset is complete, push the MENU/STORE EDIT button to store the changes, or push the STOP/CANCEL button to exit Menu mode without making any changes.
9. Display returns to stop mode.

5. RecChannel

(How to set or change the RecChannel parameters)

1. From stop, push the MENU/STORE EDIT button.
2. Push the ◀◀ or ▶▶ button to select Preset 1, 2 or 3.
3. Push the ENTER button to accept the selected Preset.
4. Push the ◀◀ or ▶▶ button so RecChannel is displayed.
5. Push the ENTER button while RecChannel is displayed. The RecChannel choice (Stereo or Mono) is flashing.
6. Push the ◀◀ or ▶▶ button to tab through the RecChannel choices.
7. When correct, push the ENTER button. Display returns to RecChannel.
8. Push the ◀◀ or ▶▶ button to select other Menu choices for editing. When editing the Preset is complete, push the MENU/STORE EDIT button to store the changes, or push the STOP/CANCEL button to exit Menu mode without making any changes.
9. Display returns to stop mode.

6. PreRecord

When PreRecord is on and the PMD660 is in record pause, it 'listens to' the selected audio input(s) and continuously buffers 2 seconds of audio. When recording begins, the 2 second pre record buffer is written at the beginning of the new track. The 2 seconds give you time to start recording without missing the first seconds of audio.

1. From stop, push the MENU/STORE EDIT button.
2. Push the ◀◀ or ▶▶ button to select Preset1, 2 or 3.
3. Push the ENTER button to accept the selected Preset.
4. Push the ◀◀ or ▶▶ button so PreRecord is displayed.
5. Push the ENTER button while PreRecord is displayed. The PreRecord choice (On or Off) is flashing.
6. Push the ◀◀ or ▶▶ button to tab through the PreRecord choices.
7. When correct, push the ENTER button. Display returns to PreRecord.
8. Push the ◀◀ or ▶▶ button to select other Menu choices for editing. When editing the Preset is complete, push the MENU/STORE EDIT button to store the changes, or push the STOP/CANCEL button to exit Menu mode without making any changes.
9. Display returns to stop mode.

7. Manual Trk

When Manual Trk incrementing is On during recording, push the REC button to increment the track. A new track is created at that point. A slight break might be heard during playback.

1. From stop, push the MENU/STORE EDIT button.
2. Push the ◀◀ or ▶▶ button to select Preset 1, 2 or 3.
3. Push the ENTER button to accept the selected Preset.
4. Push the ◀◀ or ▶▶ button so Manual Trk is displayed.
5. Push the ENTER button while Manual Trk is displayed. The Manual Trk choice (On or Off) is flashing.
6. Push the ◀◀ or ▶▶ button to tab through the Manual Trk choices.
7. When correct, push the ENTER button. Display returns to Manual Trk.
8. Push the ◀◀ or ▶▶ button to select other Menu choices for editing. When editing the Preset is complete, push the MENU/STORE EDIT button to store the changes, or push the STOP/CANCEL button to exit Menu mode without making any changes.
9. Display returns to stop mode.

8. Auto Trk

With Auto Trk (Automatic Track incrementing) on, a new track begins automatically at specified intervals of recording time.

- Automatic Tracks are silent. Playback across an Automatic Track does not produce any sound.
- Automatic Track can be set to increment every 1, 5, 10, 15 or 30 minutes, or every 1, 2, 6, 8, 12 or 24 hours.
- Automatic Track makes finding a particular point in a recording easier.

For example, if a new track begins every minute during playback :

- The Minute Tracks make finding a particular passage easier because of the relationship between track numbers and time.
- You can select track 3 to play approximately the 3rd minute of recording.
- You can go directly to the beginning of the 10th minute by selecting track 10, etc.

Track #	Recording time minutes:seconds
1.....	0:00 – 1:00
2.....	1:01 – 2:00
3.....	2:01 – 3:00

1. From stop, push the MENU/STORE EDIT button.
2. Push the ◀◀ or ▶▶ button to select Preset1, 2 or 3.
3. Push the ENTER button to accept the selected Preset.
4. Push the ◀◀ or ▶▶ button so Auto Trk is displayed.
5. Push the ENTER button while Auto Trk is displayed. The Auto Trk choice (Off, 1, 5, 10, 15 or 30 minutes, or 1, 2, 6, 8, 12 or 24 hours) is flashing.
6. Push the ◀◀ or ▶▶ button to tab through the Auto Trk choices.
7. When correct, push the ENTER button. Display returns to Auto Trk.
8. Push the ◀◀ or ▶▶ button to select other Menu choices for editing. When editing the Preset is complete, push the MENU/STORE EDIT button to store the changes, or push the STOP/CANCEL button to exit Menu mode without making any changes.
9. Display returns to stop mode.

Note:

If you intend to transfer your PMD660 audio recording to a CD, the Auto Track function makes the CD easily navigable without requiring any post production to divide files into tracks.

9. Auto Mark

The Auto Mark Menu item turns the automatic EDL mark feature Off or On. See page 25 to manually add EDL marks.

- If Auto Mark is on and the machine is in record - pause, when recording is resumed a mark will be added.
- If Auto Mark is on and the PMD660 is recording audio below the sound threshold for more than three seconds, audio that crosses the threshold will cause a mark to be added.

The Auto Mark Menu setting permits :

- Turning Auto Mark On or Off
- Adjusting the margin sound level that defines silence in -60dB, -54dB, -38dB, or -20dB.

1. From stop, push the MENU/STORE EDIT button.
2. Push the ◀◀ or ▶▶ button to select Preset1, 2 or 3.
3. Push the ENTER button to accept the selected Preset.
4. Push the ◀◀ or ▶▶ button so Auto Mark is displayed.
5. Push the ENTER button while Auto Mark is displayed. The On or Off will be flashing.
6. Push the ◀◀ or ▶▶ button to toggle between On and Off.
7. When correct, push the ENTER button. The display switches to sound level flashing.
8. Push the ◀◀ or ▶▶ button to change the margin of sound level choices (-60dB, -54dB, -38dB or -20dB).
9. When correct, push the ENTER button. Display returns to Auto Mark.
10. Push the ◀◀ or ▶▶ button to select other Menu choices for editing. When editing the Preset is complete, push the MENU/STORE EDIT button to store the changes, or push the STOP/CANCEL button to exit Menu mode without making any changes.
11. Display returns to stop mode.

Note:

The Auto Mark and Silent Skip features use the same level setting.
As the level of Auto Mark is changed, that of Silent Skip also changes automatically.

10. Silent Skip

Silent Skip automatically pauses recording when there is a period of silence and resumes recording when sound resumes. This feature is often referred to as voice activated recording.

Silent Skip looks for sound below a preset level for three seconds time.

When that occurs, the PMD660 switches to record pause. When a signal above the preset level is input, recording resumes.

The Silent Skip Menu setting permits :

- Turning Silent Skip On or Off.
- Adjusting the margin of sound level that defines silence in -60dB, -54dB, -38dB or -20dB.

When the Auto Mark menu choice is at On, resumption of recording after a record pause by Silent Skip adds an EDL mark.

1. From stop, push the MENU/STORE EDIT button.
2. Push the ◀◀ or ▶▶ button to select Preset 1, 2 or 3.
3. Push the ENTER button to accept the selected Preset.
4. Push the ◀◀ or ▶▶ button so Silent Skip is displayed.
5. Push the ENTER button while Silent Skip is displayed. The On or Off will be flashing.
6. Push the ◀◀ or ▶▶ button to toggle between On and Off.
7. When correct, push the ENTER button. The display switches to sound level flashing.
8. Push the ◀◀ or ▶▶ button to change the margin sound level choices (-60dB, -54dB, -38dB or -20dB).
9. When correct, push the ENTER button. Display returns to Silent Skip.
10. Push the ◀◀ or ▶▶ button to select other Menu choices for editing. When editing the Preset is complete, push the MENU/STORE EDIT button to store the changes, or push the STOP/CANCEL button to exit Menu mode without making any changes.
11. Display returns to stop mode.

Note:

The Auto Mark and Silent Skip features use the same level setting.

As the level of Auto Mark is changed, that of Silent Skip also changes automatically.

11. LevelCont.

The level control allows you to select the type of input level control for recording.

- At Manual, you control the input level with the REC LEVEL controls.
- At ALC, the PMD660 automatically responds to changes in input level.
(ALC: Automatic Level Control = Automatic Gain Control)

With ALC (Automatic Level Control) on:

If recording is quiet, the input level is increased.

If recording is loud, the input level is decreased.

This is a desirable feature when recording a meeting with several speakers because a speaker close to the microphone and/or with a loud voice will be automatically recorded at a reduced level. A quiet speaker will be recorded at an increased level and is less likely to have their input missed.

ALC is usually undesirable when recording music (voice or instrument) because the transitions in input level may be audible in the recording. This can make the recording 'hissy' by raising the level during quiet passages and recording ambient noise.

The REC LEVEL controls do not work when the ALC is selected.

1. From stop, push the MENU/STORE EDIT button.
2. Push the ◀◀ or ▶▶ button to select Preset 1, 2 or 3.
3. Push the ENTER button to accept the selected Preset.
4. Push the ◀◀ or ▶▶ button so LevelCont is displayed.
5. Push the ENTER button while LevelCont is displayed.
The LevelCont choice (Manual or ALC) is flashing.
6. Push the ◀◀ or ▶▶ button to tab through the LevelCont choices.
7. When correct, push the ENTER button.
Display returns to LevelCont.
8. Push the ◀◀ or ▶▶ button to select other Menu choices for editing. When editing the Preset is complete, push the MENU/STORE EDIT button to store the changes, or push the STOP/CANCEL button to exit Menu mode without making any changes.
9. Display returns to stop mode.

12. Meter Mode

The Meter Mode lets you select the type of level meters.

- At Normal, all the level meters are displayed.
 - At Peak Only, the level meter(s) displays only a peak level.
1. From stop, push the MENU/STORE EDIT button.
 2. Push the ◀◀ or ▶▶ button to select Preset 1, 2 or 3.
 3. Push the ENTER button to accept the selected Preset.
 4. Push the ◀◀ or ▶▶ button so Meter Mode is displayed.
 5. Push the ENTER button while Meter Mode is displayed.
The Meter Mode choice (Normal or Peak only) is flashing.
 6. Push the ◀◀ or ▶▶ button to tab through the Meter Mode choices.
 7. When correct, push the ENTER button.
Display returns to Meter Mode.
 8. Push the ◀◀ or ▶▶ button to select other Menu choices for editing. When editing the Preset is complete, push the MENU/STORE EDIT button to store the changes, or push the STOP/CANCEL button to exit Menu mode without making any changes.
 9. Display returns to stop mode.

Note:

When Peak Only is set, the battery life will be extended.

13. Mic Atten.

The Mic Atten. let you select the direct use of microphones that differ in sensitivity.

- At 0dB there is no microphone attenuation.
 - At -20dB, Input from a microphone(s) connected to the XLR MIC IN jacks is cut by -20dB.
1. From stop, push the MENU/STORE EDIT button.
 2. Push the ◀◀ or ▶▶ button to select Preset 1, 2 or 3.
 3. Push the ENTER button to accept the selected Preset.
 4. Push the ◀◀ or ▶▶ button so Mic Atten is displayed.
 5. Push the ENTER button while Mic Atten is displayed.
The Mic Atten choice (0dB or -20dB) is flashing.
 6. Push the ◀◀ or ▶▶ button to tab through the Mic Atten choices.
 7. When correct push the ENTER button.
Display returns to Mic Atten.
 8. Push the ◀◀ or ▶▶ button to select other Menu choices for editing. When editing the Preset is complete, push the MENU/STORE EDIT button to store the changes, or push the STOP/CANCEL button to exit Menu mode without making any changes.
 9. Display returns to stop mode.

14. AutoPowOff

If the PMD660 is not used for 15 minutes during stop or play - pause, power can be automatically shut off to conserve battery life.

1. From stop, push the MENU/STORE EDIT button.
2. Push the ◀◀ or ▶▶ button to select Preset 1, 2 or 3.
3. Push the ENTER button to accept the selected Preset.
4. Push the ◀◀ or ▶▶ button so AutoPowOff is displayed.
5. Push the ENTER button while AutoPowOff is displayed. The AutoPowOff choice (On or Off) is flashing.
6. Push the ◀◀ or ▶▶ button to tab through the AutoPowOff choices.
7. When correct, push the ENTER button. Display returns to AutoPowOff.
8. Push the ◀◀ or ▶▶ button to select other Menu choices for editing. When editing the Preset is complete, push the MENU/STORE EDIT button to accept the changes, or push the STOP/CANCEL button to exit Menu mode without making any changes.
9. Display returns to stop mode.

15. Battery

The PMD660 operates on 4 standard AA size Alkaline, or Ni-MH batteries.

1. From stop, push the MENU/STORE EDIT button.
2. Push the ◀◀ or ▶▶ button to select Preset 1, 2 or 3.
3. Push the ENTER button to accept the selected Preset.
4. Push the ◀◀ or ▶▶ button so Battery is displayed.
5. Push the ENTER button while Battery is displayed. The Battery choice (Alkaline or NiMH) is flashing.
6. Push the ◀◀ or ▶▶ button to tab through the Battery choices.
7. When correct, push the ENTER button. Display returns to Battery.
8. Push the ◀◀ or ▶▶ button to select other Menu choices for editing. When editing the Preset is complete, push the MENU/STORE EDIT button to accept the changes, or push the STOP/CANCEL button to exit Menu mode without making any changes.
9. Display returns to stop mode.

16. Beep

When battery charge is depleted and Beep is set to On, the PMD660 will beep.

If the PMD660 is not used for 15 minutes during stop or play - pause, power can be automatically shut off to conserve battery life. (See AutoPowOff page 53.)

If AutoPowOff and Beep are both set to On, the PMD660 will beep to alert you that the power is shutting off.

1. From stop, push the MENU/STORE EDIT button.
2. Push the ◀◀ or ▶▶ button to select Preset 1, 2 or 3.
3. Push the ENTER button to accept the selected Preset.
4. Push the ◀◀ or ▶▶ button until Beep is displayed.
5. Push the ENTER button while Beep is displayed.
The Beep choice (On or Off) is flashing.
6. Push the ◀◀ or ▶▶ button to tab through the Beep choices.
7. When correct, push the ENTER button.
Display returns to Beep.
8. Push the ◀◀ or ▶▶ button to select other Menu choices for editing. When editing the Preset is complete, push the MENU/STORE EDIT button to store the changes, or push the STOP/CANCEL button to exit Menu mode without making any changes.
9. Display returns to stop mode.

17. Machine ID

An audio track (file) has Machine ID information.

This information is included in the file name.

For example, if the Machine ID is "aaaaa", the first file is numbered "aaaaa001.wav" or "aaaaa001.mp3".

1. From stop, push the MENU/STORE EDIT button.
2. Push the ◀◀ or ▶▶ button to select Preset 1, 2 or 3.
3. Push the ENTER button to accept the selected Preset.
4. Push the ◀◀ or ▶▶ button until Machine ID is displayed.
5. Push the ENTER button while Machine ID is displayed.
The first character of the Machine ID will be flashing.
6. Push the ◀◀ or ▶▶ button to select the characters.
7. When correct, push the ENTER button.
The next position will be flashing.
Repeat steps 6 and 7 until all Machine ID characters are correct.
8. After the last character, push the ENTER button.
The display returns to the Machine ID.
9. Push the ◀◀ or ▶▶ button to select other Menu choices for editing. When editing the Preset is complete, push the MENU/STORE EDIT button to store the changes, or push the STOP/CANCEL button to exit Menu mode without making any changes.
10. Display returns to stop mode.

Note:

The Machine ID setting applies to all three presets.

18. Default

The Default menu choice resets all Menu (not Edit menu) items in the Preset to their default values.

This is convenient if you are setting up a new Preset configuration because you do not have to check all the settings - you know they are at the default.

Note:

US defaults are used for illustration.

See page 42, 43 for a table of menu defaults.

Defaults are listed for each menu item.

1. From stop, push the MENU/EDIT button.
2. Push the ◀◀ or ▶▶ button to select Preset 1, 2 or 3.
3. Push the ENTER button to accept the selected Preset.
4. Push the ◀◀ or ▶▶ button until Default is displayed.
5. Push the ENTER button while Default is displayed.
The OK? is flashing.
6. Push the ENTER button.
Display returns to stop mode.

Troubleshooting

Should problems occur, it is often unnecessary to consult your dealer or technical service department. On the basis of the following checks, you may be able to rectify a number of conditions yourself without difficulty. If the condition cannot be remedied after the following check, please consult your dealer, or contact Marantz Professional at 866-405-2154 (Toll Free).

The PMD660 does not turn on.

- Install fresh batteries.
- Check AC adapter connections.

The PMD660 turns on then turns itself off.

- Install fresh batteries.

The PMD660 seems to record, but there is no sound on playback.

- Check input settings.
(For example, if LINE input is selected and no input is connected to the LINE IN jack, the PMD660 will record silence. The PMD660 will not playback.)
- Check output settings.
(For example, if the output selected is LINE, no sound output is available in the speaker or headphones (SP/HP) or vice versa.)

There is no audio playback through headphones or internal speaker.

- Check HP/SPK VOL control setting.
- Check a different track or CF card.
- Check output setting.

The PMD660 will not record.

- Check that the maximum of 999 tracks have not been recorded.
- Check that the PMD660 acknowledges the CF card.

No signal from microphone input.

- Check input selection.
- Check REC level control settings.
- Check if microphone(s) require(s) Phantom power.

There is excessive noise on the PMD660.

- Check cable connections and/or replace cable.
- Check for proper gain levels.

Playback on a PC results in poor sound.

- Check quality of PC sound card and program.
- Check frequency conversion program.*

* The PMD660 records audio files with a sampling frequency of 48kHz. Some PC programs convert the files to 44.1kHz (using a sample rate converter). Only high quality sample rate converters should be used.

PC cannot read files

- Check the capability of the PC program. Some playback and editing programs do not support MP3 or Broadcast Wave (.wav) formats.

If the PMD660 exhibits erratic behavior, the microprocessor can be reset by powering off, disconnecting AC power and removing batteries.

Care and Maintenance

Use a soft cloth slightly moistened with mild detergent solution.

Media cards that are heavily used should be occasionally reformatted to avoid audio problems due to fragmentation.

Error Message

Display	Description
CF Card	
No Card	No CF card inserted, or card is not detected.
Unformat	CF card is formatted other than FAT16 or FAT32.
Full Card	Remaining capacity of CF card is less than a few kbytes.
Full 999	The number of tracks on the CF card has reached the 999 maximum.
Full Mark	The number of EDL marks on the card has reached the 255 maximum.
No Track	Track file is not detected.
VBR	VBR file is forwarded or rewinded.
No Mark	Mark of track file is not detected.
Can not...	Invalid operation.
LowBattery	Battery voltage is low.
Need DC IN	AC adapter is not connected to PMD660.
Bad File	The menu setting of the file setting is not detected or file error.
Err FS	Version up file or file system error.
Full V99	Copy track (Virtual Track) file is 99 track.
No V.Track	Copy track (Virtual Track) file is not detected.
Limit 80m	Copy track (Virtual Track) time set to over 80 minutes.
Err Format	Not supported file format.
Others	
Err DSP	DSP processing error.
Err Card	Card or File error.
Err RTC	RTC processing error.
Err EEPROM	EEPROM error.
Err SRAM	SRAM error.
Err Flash	Flash ROM error.

Specifications

Digital audio system

System Solid State Recorder
Usable media CF memory cards
Microdrive

Recording and media methods

.mp3 MPEG1 Layer III compression
PCM 16 bit linear PCM

Recording bit rate

MP3 mono 64 kbps
MP3 stereo 128 kbps

Sampling frequency 44.1, 48 kHz
Number of channels 2 (stereo), 1 (mono)
Frequency response 16,000 Hz (-0.5dB)

Signal-to-Noise Ratio

IEC-A weighted LINE 80 dB
MIC 60 dB

Total harmonic distortion

at 0 VU (PCM) LINE 0.06%
MIC 0.15%

Dynamic range 80 dB

Inputs

MIC IN L/R
Type XLR (1:GND, 2:HOT, 3:COLD)
Input sensitivity (MIC) 1.2 mVrms/6.5 kohms

LINE IN

Type mini jack
Input sensitivity 300 mVrms/20 kohms

Outputs

LINE OUT

Type mini jack
Standard level 2 Vrms max./2 kohms

General

Headphone output power 8 mW/ 16 ohms
Speaker output power 150 mW/ 8 ohms
Phantom power +48V, 5mA

Power consumption

Recording/Playback 4.0 W (DC)
Battery life (Alkaline) 4 hours (typical)

Dimensions

Width 113 mm (4.5")
Height 47 mm (1.9")
Depth 183.5 mm (7.2")
Weight 0.5 kg (1.1 lbs.)

Included accessories

CF card (64MB) (US only) 1
 AC adapter 1
 USB cable 1
 Audio cable 1
 Carry strap 1
 Screws (ISO 3x10 mm) 2
 Plastic pin and retainer 1
 CD-ROM 1
 User Guide 1

Optional accessories**

(See www.d-mpro.com for description and/or ordering information)

Wired remoteRC600PMD

* Specifications subject to change without notice.

LIMITED WARRANTY - USA

Your Marantz Professional product is warranted against manufacturer defects in material and workmanship for a period of one year parts and labor. Marantz will pay for labor and material expenses for items covered by this limited warranty.

Except as specified below, this warranty covers defects in material and workmanship. The following are not covered under warranty:

1. Damage, deterioration, malfunction or failure to meet performance specifications resulting from:
 - a) Accidents, acts of nature, misuse, abuse, neglect or unauthorized product modification.
 - b) Improper installation, removal or maintenance, or failure to follow supplied instructions.
 - c) Repair or attempted repair by a non-Marantz authorized agent.
 - d) Any shipment (claims must be presented to the carrier).
 - e) Any cause other than a defect of manufacturing.
2. Cleaning, check-ups with no fault found or changes incurred for installation, removal or reinstallation of the product.
3. Any serialized product on which the serial number has been defaced, modified or removed.
4. Batteries and battery chargers.
5. Accessories, including but not limited to: cables, mounting hardware and brackets, cleaning accessories, power cords and adapters, and carry cases.
6. Products purchased outside of the United States, its possessions or territories.

Non-transferable warranty

This Warranty may be enforced only by the original purchaser.

Service Information

1. If your unit needs service in the USA, contact our service referral at the appropriate telephone number indicated below. We will advise you of the name and location of one or more authorized service centers from which service may be obtained. Please do not return the unit directly to us.
2. You must pay any shipping charges if it is necessary to ship the product for service. If the necessary repairs are covered by the warranty, we will pay return shipping charges to your location anywhere in the United States or its territories.
3. Whenever warranty service is required, you must present the original dated sales receipt or other proof of date purchased.

Limitation of Implied warranties

All implied warranties, including warranties of merchantability and fitness for a particular purpose, are limited in duration to the length of this warranty.

Exclusion of Damages

Liability for any defective product is limited to the product's repair or replacement at manufacturer's option. Manufacturer shall not be liable for damage to other products caused by any defects in Marantz products, damages based on inconvenience or loss of use of the product, or any other damages, whether incidental, consequential, or otherwise.

Some States do not allow limitations on how long an implied warranty lasts and/or do not allow the exclusion or limitation of incidental or consequential damages, so the above limitations and exclusions may not apply to you.

How state law relates to the warranty

This warranty gives you specific legal rights, and you may have other rights which vary from State to State.

Marantz Professional service number:

Marantz Professional Factory Service (866)405-2154
This warranty is enforceable only in the United States and its possessions or territories.

marantz®

Printed in Japan

Marantz is a registered trademark.



2005/02 00M20BS851310 mzh-g